

Whaikaha - Ministry of Disabled People

List Equipment

Band 1 (pages 2 - 54)

Band 2 & 3 (pages 55 - 124)



Version: 41
Issued: 12/06/2023

Whaikaha - Ministry of Disabled People

Band 1 List Equipment

Band 1 Substitutes

- Equipment on the Band 1 List may be substituted for a similar product with essentially the same form and function
- Where a substitute item is available from the stores, this will be issued first rather than buying new. As this is an automated process there is no ability to select an exact item.
- If an exact Band 1 item is required and no substitute is acceptable, please complete via a Band 2 application with rationale to ensure exact item.

Table of Contents

Ambulatory	3
Bedroom	8
Communication Assistive Technology	12
Hearing Assistive Technology	13
Kitchen & Living	18
Manual Handling	25
Paediatric	27
Shower & Bath	32
Toileting	37
Wheelchairs & Seating	40
Products under \$50	43

Whaikaha - Ministry of Disabled People Band 1 List Equipment

Ambulatory

Walking Frame - Light Weight

Band 1



SPECIFICATIONS

Folding
Lightweight aluminium

SUPPLIER

Tubular Equipment

DIMENSIONS

610mm overall width
790-920mm adjustable height

BRAND

Tubular Equipment

MAX USER WEIGHT

160kg

SUPPLIER PRODUCT ID	JDE#	SPECIFICATIONS	PRICE BREAK	ORDERING CODE	DHB SERVICE ACCREDITATION
AF1101	773521	4 Stoppers	\$50-\$250	WF5	No
AF1103G	773548	Front castors / rear glide feet	\$250-\$500	WF6	No
AF1102G	773601	Front wheels / rear glide feet	\$250-\$500	WF9	Yes
AF1103	773564	Front castors / rear stoppers	\$250-\$500	WF7	No
AF1102	773628	Front wheels / rear stoppers	\$50-\$250	WF10	No

Accessories

DESCRIPTION	JDE#	SUPPLIER PRODUCT ID	PRICE BREAK	ORDERING CODE	DHB SERVICE ACCREDITATION
Basket/tray	830400	BSKT88	\$50-\$250	PA26	Yes

Whaikaha - Ministry of Disabled People Band 1 List Equipment

Ambulatory

Walking Frame - Standard Band 1



SPECIFICATIONS

Pacer
Folding
Standard with basket and tray

SUPPLIER

Cubro

DIMENSIONS

570mm overall width
755-990mm adjustable height

BRAND

Pacer

MAX USER WEIGHT

160kg



SUPPLIER PRODUCT ID	JDE#	SPECIFICATIONS	PRICE BREAK	ORDERING CODE	DHB SERVICE ACCREDITATION
1875HB	754144	Front castors / rear wheels and Handbrake	\$250-\$500	WF53	Yes

Whaikaha - Ministry of Disabled People Band 1 List Equipment

Ambulatory

Walking Frame - Rollator

Band 1



 		SPECIFICATIONS Low seat Height adjustable seat Lightweight aluminium Premium stroller/rollator low seat 4 wheels Standard with bag	
SUPPLIER		DIMENSIONS	
Independent Living Service		6" wheels 590mm overall width 460-500mm adj seat height 745-885m adj handle height	
BRAND		MAX USER WEIGHT	
Independent Living Service		136kg	
SUPPLIER PRODUCT ID	JDE#	PRICE BREAK	ORDERING CODE
ILS-9288S	880212	\$50-\$250	WF43

Accessories

DESCRIPTION	JDE#	SUPPLIER PRODUCT ID	PRICE BREAK	ORDERING CODE	DHB SERVICE ACCREDITATION
Tray	880221	ILS-9288-TR	\$50-\$250	WF49	Yes

Walking Frame - Rollator

Band 1

 		SPECIFICATIONS Lightweight aluminium Height adjustable seat Premium stroller/rollator 4 wheels Standard with bag			
SUPPLIER		DIMENSIONS			
Independent Living Service		6" wheels 590mm overall width 520-590mm adj seat height 815-980m adj handle height		8" wheels 590mm overall width 545-620mm adj seat height 850-1010mm adj handle height	
BRAND		MAX USER WEIGHT			
Independent Living Service		136kg			
SUPPLIER PRODUCT ID	JDE#	SPECIFICATIONS	PRICE BREAK	ORDERING CODE	DHB SERVICE ACCREDITATION
ILS-9288-6	880191	6" wheels	\$50-\$250	WF40	Yes
ILS-9288-8	880204	8" wheels	\$50-\$250	WF51	No
Accessories					
DESCRIPTION	JDE#	SUPPLIER PRODUCT ID	PRICE BREAK	ORDERING CODE	DHB SERVICE ACCREDITATION
Tray	880221	ILS-9288-TR	\$50-\$250	WF49	Yes

Whaikaha - Ministry of Disabled People Band 1 List Equipment

Ambulatory

Walking Frame - Rollator		Band 1	
		SPECIFICATIONS	
		Heavy Duty High strength tubing 4 wheels	
SUPPLIER		DIMENSIONS	
Independent Living Service		8" Wheels 610mm overall width 870-980mm adjustable height	
BRAND		MAX USER WEIGHT	
Independent Living Service		200kg	
SUPPLIER PRODUCT ID	JDE#	PRICE BREAK	ORDERING CODE
ILS-9201M	883991	\$250-\$300	WF116

Walking Frame - Rollator		Band 1	
		SPECIFICATIONS	
		Bariatric High strength tubing 4 wheels	
SUPPLIER		DIMENSIONS	
Allied Medical Ltd		735mm overall width 875-980mm adjustable height	
BRAND		MAX USER WEIGHT	
Maxhealth		230kg	
SUPPLIER PRODUCT ID	JDE#	PRICE BREAK	ORDERING CODE
MP10200	829038	\$250-\$300	WF25

Whaikaha - Ministry of Disabled People Band 1 List Equipment

Ambulatory

Walking Frame - Gutter Band 1

		SPECIFICATIONS		
		Adjustable forearm support 6inch Castors and Wheels		
SUPPLIER		DIMENSIONS		
Cubro		475mm overall width 800-1250mm adjustable height		
BRAND		MAX USER WEIGHT		
Pacer		160kg		
SUPPLIER PRODUCT ID	JDE#	SPECIFICATIONS	PRICE BREAK	ORDERING CODE
1905HB	754881	Front castors / rear wheels and Handbrake	\$750-\$1000	WF115
Accessories				
DESCRIPTION	JDE#	SUPPLIER PRODUCT ID	PRICE BREAK	ORDERING CODE
Basket/tray	766022	1642	\$50-\$250	WF107

Walking Frame - Gutter Band 1

		SPECIFICATIONS		
		Adjustable forearm support with Handbrakes 8inch Castors and Wheels		
SUPPLIER		DIMENSIONS		
Tubular Equipment		630mm overall width 950-1300mm adjustable height		
BRAND		MAX USER WEIGHT		
Tubular Equipment		200kg		
SUPPLIER PRODUCT ID	JDE#	SPECIFICATIONS	PRICE BREAK	ORDERING CODE
EFR1007C8B	853020	Front castors / rear wheels and Handbrake	\$1000-\$1500	WF117
Accessories				
DESCRIPTION	JDE#	SUPPLIER PRODUCT ID	PRICE BREAK	ORDERING CODE
Basket/tray	892512	BSKTEFR88	\$50-\$250	WF118

Whaikaha - Ministry of Disabled People Band 1 List Equipment

Bedroom

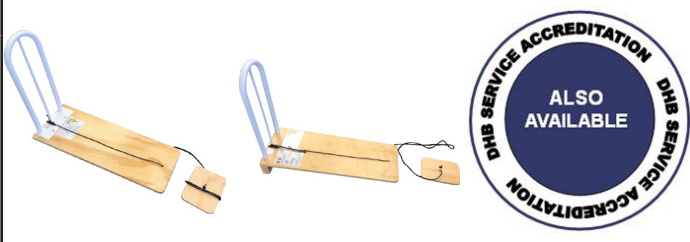

Bed Lever							Band 1
				SPECIFICATIONS			
				Bed Lever with anti-entrapment bar, cord and cleat			
SUPPLIER				DIMENSIONS			
Tastech Services Ltd				290mm width of board			
BRAND				MAX USER WEIGHT			
Tastech Services Ltd				150kg			
SUPPLIER PRODUCT ID	JDE#	LOOP HEIGHT	BOARD LENGTH	BOARD BOTTOM	PRICE BREAK	ORDERING CODE	
BLF3-600	893380	550mm	600mm	Flat	\$50-\$250	B289	
BLF3	893398	550mm	800mm	Flat	\$50-\$250	B290	
BL3-600	895959	550mm	600mm	Block	\$50-\$250	B291	
BL3	895967	550mm	800mm	Block	\$50-\$250	B292	

Bed Pole				Band 1
		SPECIFICATIONS		
		Freestanding over bed pole		
SUPPLIER		DIMENSIONS		
Superquip Ltd		1785mm height 885mm min handle height		
BRAND		MAX USER WEIGHT		
Superquip		120kg		
SUPPLIER PRODUCT ID	JDE#	PRICE BREAK	ORDERING CODE	
070	759156	\$250-\$500	B4	



Whaikaha - Ministry of Disabled People Band 1 List Equipment

Bedroom

Overbed Table Band 1

 		SPECIFICATIONS Tilt top H Base	
SUPPLIER		DIMENSIONS	
Invacare New Zealand		380x800mm top size 760-1050mm adjustable height	
BRAND		MAX USER WEIGHT	
Invacare New Zealand		N/A	
SUPPLIER PRODUCT ID	JDE#	PRICE BREAK	ORDERING CODE
6418	834283	\$50-\$250	B17

Overbed/chair Table Band 1



 		SPECIFICATIONS Tilt Top U Base	
SUPPLIER		DIMENSIONS	
Cubro		450x750mm top size 600-960mm adjustable height	
BRAND		MAX USER WEIGHT	
		N/A	
SUPPLIER PRODUCT ID	JDE#	PRICE BREAK	ORDERING CODE
575	876205	\$250-\$300	B259

Whaikaha - Ministry of Disabled People Band 1 List Equipment

Bedroom

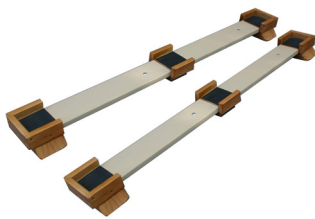

Bed Raiser

Band 1

 		SPECIFICATIONS Double bed raiser Set of 2 Suits all sizes of double beds that have legs, glides or castor wheels		
SUPPLIER Multifit Hospital Supplies Ltd		DIMENSIONS 90x90mm foot pad 150-1700mm adjustable width Standard double to Superking size		
BRAND Multifit Hospital Supplies		MAX USER WEIGHT 380kg		
SUPPLIER PRODUCT ID	JDE#	HEIGHT	PRICE BREAK	ORDERING CODE
MF2/4-50/2	760616	50mm	\$250-\$500	K14-50/2
MF2/4-75/2	760632	75mm	\$250-\$500	K14-75/2
MF2/4-100/2	760579	100mm	\$250-\$500	K14-100/2
MF2/4-150/2	760595	150mm	\$250-\$500	K14-150/2

Bed Raiser

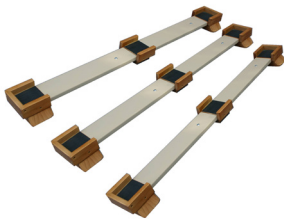
Band 1

 		SPECIFICATIONS Double bed raiser Set of 3 Suits all sizes of double beds that have legs, glides or castor wheels		
SUPPLIER Multifit Hospital Supplies Ltd		DIMENSIONS 90x90mm foot pad 150-1700mm adjustable width Standard double to Superking size		
BRAND Multifit Hospital Supplies		MAX USER WEIGHT 380kg		
SUPPLIER PRODUCT ID	JDE#	HEIGHT	PRICE BREAK	ORDERING CODE
MF2/4-50/3	760624	50mm	\$250-\$500	K15-50/3
MF2/4-75/3	760641	75mm	\$250-\$500	K15-75/3
MF2/4-100/3	760587	100mm	\$250-\$500	K15-100/3
MF2/4-150/3	760608	150mm	\$250-\$500	K15-150/3

Whaikaha - Ministry of Disabled People Band 1 List Equipment

Bedroom

Bed Raiser

Band 1



SPECIFICATIONS

Single bed troughs
Set of 3

Suits single beds that have legs, glides or castor wheels

SUPPLIER

Multifit Hospital Supplies Ltd

DIMENSIONS

90 x 90mm foot pad
815-1100mm adjustable width

BRAND

Multifit Hospital Supplies

MAX USER WEIGHT

380kg

SUPPLIER PRODUCT ID	JDE#	HEIGHT	PRICE BREAK	ORDERING CODE
MF2/2-50/3	760712	50mm	\$250-\$500	K16-50/3
MF2/2-75/3	760691	75mm	\$250-\$500	K16-75/3
MF2/2-100/3	760683	100mm	\$250-\$500	K16-100/3
MF2/2-150/3	760704	150mm	\$250-\$500	K16-150/3

Whaikaha - Ministry of Disabled People Band 1 List Equipment

Communication Assistive Technology

Artificial Larynges		Band 1	
		SPECIFICATIONS	
		Electrolarynx TruTone EMOTE	
SUPPLIER		DIMENSIONS	
Atos Medical			
BRAND		MAX USER WEIGHT	
Atos/Griffin		N/A	
SUPPLIER PRODUCT ID	JDE#	PRICE BREAK	ORDERING CODE
7439	888644	Over \$1000	CM11

Whaikaha - Ministry of Disabled People Band 1 List Equipment

Hearing Assistive Technology

Alarm Clock		Band 1	
		SPECIFICATIONS	
		Visit alarm clock with wireless receiver and shaker includes charger	
SUPPLIER		DIMENSIONS	
Reid Technology			
BRAND		MAX USER WEIGHT	
Bellman		N/A	
SUPPLIER PRODUCT ID	JDE#	PRICE BREAK	ORDERING CODE
BE1380	835569	\$250-\$500	CM12

Door Alarm Transmitter		Band 1	
		SPECIFICATIONS	
		Visit wireless doorbell Push button door / alarm transmitter	
SUPPLIER		DIMENSIONS	
Reid Technology			
BRAND		MAX USER WEIGHT	
Bellman		N/A	
SUPPLIER PRODUCT ID	JDE#	PRICE BREAK	ORDERING CODE
BE1240	831568	\$50-\$250	CM2

Baby Transmitter		Band 1	
		SPECIFICATIONS	
		Visit baby monitor Baby cry transmitter	
SUPPLIER		DIMENSIONS	
Reid Technology			
BRAND		MAX USER WEIGHT	
Bellman		N/A	
SUPPLIER PRODUCT ID	JDE#	PRICE BREAK	ORDERING CODE
BM1491	798585	\$50-\$250	CM4

Whaikaha - Ministry of Disabled People Band 1 List Equipment

Hearing Assistive Technology

Portable Receiver		Band 1	
		SPECIFICATIONS	
		Visit portable receiver (mains/battery powered) Use mains power when in use with a pillow shaker (comes with power supply)	
SUPPLIER		DIMENSIONS	
Reid Technology			
BRAND		MAX USER WEIGHT	
Bellman		N/A	
SUPPLIER PRODUCT ID	JDE#	PRICE BREAK	ORDERING CODE
BE1033-KIT	796758	\$250-\$500	CM6

Telephone Transmitter		Band 1	
		SPECIFICATIONS	
		Visit telephone transmitter	
SUPPLIER		DIMENSIONS	
Reid Technology			
BRAND		MAX USER WEIGHT	
Bellman		N/A	
SUPPLIER PRODUCT ID	JDE#	PRICE BREAK	ORDERING CODE
BE1431	808376	\$50-\$250	CM13

Bed/Pillow Shaker		Band 1	
		SPECIFICATIONS	
		Bed shaker	
SUPPLIER		DIMENSIONS	
Reid Technology			
BRAND		MAX USER WEIGHT	
Bellman		N/A	
SUPPLIER PRODUCT ID	JDE#	PRICE BREAK	ORDERING CODE
BE1270	798260	\$50-\$250	CM3

Whaikaha - Ministry of Disabled People Band 1 List Equipment

Hearing Assistive Technology

Flash Receiver				Band 1
		SPECIFICATIONS		
		Visit flash receiver		
SUPPLIER		DIMENSIONS		
Reid Technology				
BRAND		MAX USER WEIGHT		
Bellman		N/A		
SUPPLIER PRODUCT ID	JDE#	PRICE BREAK	ORDERING CODE	
BE1443	805440	\$250-\$500	CM7	

Smoke Alarm Transmitter				Band 1
		SPECIFICATIONS		
		Visit Smoke Alarm Sealed, non-replaceable, 10 Year Lithium Battery.		
SUPPLIER		DIMENSIONS		
Reid Technology				
BRAND		MAX USER WEIGHT		
Bellman		N/A		
SUPPLIER PRODUCT ID	JDE#	PRICE BREAK	ORDERING CODE	
BE1289	869671	\$250-\$500	CM14	

Pager Receiver				Band 1
		SPECIFICATIONS		
		Visit pager receiver		
SUPPLIER		DIMENSIONS		
Reid Technology				
BRAND		MAX USER WEIGHT		
Bellman		N/A		
SUPPLIER PRODUCT ID	JDE#	PRICE BREAK	ORDERING CODE	
BE1230	798577	\$250-\$500	CM8	

Accessories				
DESCRIPTION	JDE#	SUPPLIER PRODUCT ID	PRICE BREAK	ORDERING CODE
Charger	786381	BE1260	\$250-\$500	CM9

Whaikaha - Ministry of Disabled People Band 1 List Equipment

Hearing Assistive Technology

Smoke Alarm Controller		Band 1	
		SPECIFICATIONS	
		RadioLINK Alarm Controller	
SUPPLIER		DIMENSIONS	
National Fire & Security			
BRAND		MAX USER WEIGHT	
EI Electronics		N/A	
SUPPLIER PRODUCT ID	JDE#	PRICE BREAK	ORDERING CODE
EIB450	869689	\$50-\$250	CM15

Strobe Light/Vibrating Pad		Band 1	
		SPECIFICATIONS	
		RadioLINK Strobe Light & Vibration Pad Module	
SUPPLIER		DIMENSIONS	
National Fire & Security			
BRAND		MAX USER WEIGHT	
EI Electronics		N/A	
SUPPLIER PRODUCT ID	JDE#	PRICE BREAK	ORDERING CODE
EIB170RFAU	869697	\$250-\$500	CM16

Smoke Alarm		Band 1	
		SPECIFICATIONS	
		RadioLINK Smoke Alarm	
SUPPLIER		DIMENSIONS	
National Fire & Security			
BRAND		MAX USER WEIGHT	
EI Electronics		N/A	
SUPPLIER PRODUCT ID	JDE#	PRICE BREAK	ORDERING CODE
EIB650ICRF	869700	\$50-\$250	CM17

Whaikaha - Ministry of Disabled People Band 1 List Equipment

Hearing Assistive Technology

Strobe Light Only		Band 1	
		SPECIFICATIONS	
		RadioLINK Strobe Light only	
SUPPLIER		DIMENSIONS	
National Fire & Security			
BRAND		MAX USER WEIGHT	
EI Electronics		N/A	
SUPPLIER PRODUCT ID	JDE#	PRICE BREAK	ORDERING CODE
EIB171RFAU	869718	\$250-\$500	CM18

Vibrating Pad Only		Band 1	
		SPECIFICATIONS	
		RadioLINK Vibration Pad only	
SUPPLIER		DIMENSIONS	
National Fire & Security			
BRAND		MAX USER WEIGHT	
EI Electronics		N/A	
SUPPLIER PRODUCT ID	JDE#	PRICE BREAK	ORDERING CODE
EIB174	869726	\$50-\$250	CM19



Whaikaha - Ministry of Disabled People Band 1 List Equipment

Kitchen & Living



Step With Handle Band 1

		SPECIFICATIONS	
		Bath step adjustable height Rust Free Aluminium Non slip mat.	
SUPPLIER		DIMENSIONS	
Goldfern Mobility		450x320mm step size 200-250mm platform height 1050-1100mm handle height	
BRAND		MAX USER WEIGHT	
Goldfern Mobility		130kg	
SUPPLIER PRODUCT ID	JDE#	PRICE BREAK	ORDERING CODE
GM-HMP-8335	869831	\$50-\$250	K4

Perching Stool with Arms Band 1

 		SPECIFICATIONS	
		Adjustable height	
SUPPLIER		DIMENSIONS	
Allied Medical Ltd		320mm seat width 490mm width between arms	
BRAND		MAX USER WEIGHT	
Maxhealth		113kg	
SUPPLIER PRODUCT ID	JDE#	PRICE BREAK	ORDERING CODE
AML3035	764596	\$50-\$250	K9



Kitchen Trolley Band 1



 		SPECIFICATIONS	
		Without handle	
SUPPLIER		DIMENSIONS	
Tastech Services Ltd		430mm width 430mm depth 810mm height	
BRAND		MAX WEIGHT ON TRAY	
Tastech Services		30kg	
SUPPLIER PRODUCT ID	JDE#	PRICE BREAK	ORDERING CODE
RT1	766111	\$50-\$250	K8

© All contents within this document are the copyrighted property of Enable New Zealand. Contents may not be copied, reproduced, modified, published, uploaded, posted, transmitted or distributed in any way without the prior written consent of Enable New Zealand.

Whaikaha - Ministry of Disabled People Band 1 List Equipment

Kitchen & Living

Kitchen Trolley		Band 1	
 		SPECIFICATIONS With handle	
SUPPLIER		DIMENSIONS	
Tastech Services Ltd		430mm width 430mm depth 870mm height	
BRAND		MAX WEIGHT ON TRAY	
Tastech Services		30kg	
SUPPLIER PRODUCT ID	JDE#	PRICE BREAK	ORDERING CODE
RT1H	766102	\$50-\$250	K8-H

Kitchen Trolley		Band 1	
 		SPECIFICATIONS	
SUPPLIER		DIMENSIONS	
Cubro		465mm width 490mm length 785-935mm adjustable height	
BRAND		MAX WEIGHT ON TRAY	
Chevron		10kg	
SUPPLIER PRODUCT ID	JDE#	PRICE BREAK	ORDERING CODE
290	766081	\$50-\$250	K11

Whaikaha - Ministry of Disabled People Band 1 List Equipment

Kitchen & Living

Chair/Bed Blocks Band 1

		SPECIFICATIONS		
		Set of 4		
SUPPLIER		DIMENSIONS		
Tastech Services Ltd		130x130mm size		
BRAND		MAX USER WEIGHT		
Tastech Services		600kg		
SUPPLIER PRODUCT ID	JDE#	HEIGHT	PRICE BREAK	ORDERING CODE
CB1-4	810601	50mm	\$50-\$250	K12-50 4
CB2-4	810628	75mm	\$50-\$250	K12-75 4
CB3-4	810564	100mm	\$50-\$250	K12-100 4
CB4-4	810581	150mm	\$50-\$250	K12-150 4

Chair/Bed Blocks Band 1

		SPECIFICATIONS		
		Set of 6		
SUPPLIER		DIMENSIONS		
Tastech Services Ltd		130x130mm size		
BRAND		MAX USER WEIGHT		
Tastech Services		600kg		
SUPPLIER PRODUCT ID	JDE#	HEIGHT	PRICE BREAK	ORDERING CODE
CB1-6	810599	50mm	\$50-\$250	K12-50 6
CB2-6	810610	75mm	\$50-\$250	K12-75 6
CB3-6	810556	100mm	\$50-\$250	K12-100 6
CB4-6	810572	150mm	\$50-\$250	K12-150 6

Whaikaha - Ministry of Disabled People Band 1 List Equipment

Kitchen & Living

Chair/Bed Blocks Band 1

		SPECIFICATIONS Castors Set of 4		
SUPPLIER		DIMENSIONS		
Tastech Services Ltd		130x130mm size		
BRAND		MAX USER WEIGHT		
Tastech Services		600kg		
SUPPLIER PRODUCT ID	JDE#	HEIGHT	PRICE BREAK	ORDERING CODE
CB1C-4	810521	50mm	\$50-\$250	K12-50C 4
CB2C-4	810548	75mm	\$50-\$250	K12-75C 4
CB3C-4	810484	100mm	\$50-\$250	K12-100C 4
CB4C-4	810505	150mm	\$50-\$250	K12-150C 4

Chair/Bed Blocks Band 1

		SPECIFICATIONS Castors Set of 6		
SUPPLIER		DIMENSIONS		
Tastech Services Ltd		130x130mm size		
BRAND		MAX USER WEIGHT		
Tastech Services		600kg		
SUPPLIER PRODUCT ID	JDE#	HEIGHT	PRICE BREAK	ORDERING CODE
CB1C-6	810513	50mm	\$50-\$250	K12-50C 6
CB2C-6	810530	75mm	\$50-\$250	K12-75C 6
CB3C-6	810476	100mm	\$50-\$250	K12-100C 6
CB4C-6	810492	150mm	\$50-\$250	K12-150C 6

Whaikaha - Ministry of Disabled People Band 1 List Equipment

Kitchen & Living

Sofa Raiser

Band 1



SPECIFICATIONS

Set of 2
Fits any standard sofa that has legs, glides or castor wheels

SUPPLIER

Multifit Hospital Supplies Ltd

DIMENSIONS

90x90mm foot pad size
624-900mm adjustable width

BRAND

Multifit Hospital Supplies

MAX USER WEIGHT

380kg

SUPPLIER PRODUCT ID	JDE#	HEIGHT	PRICE BREAK	ORDERING CODE
MF2/1-50/2	760747	50mm	\$250-\$500	K3-50/2
MF2/1-75/2	760755	75mm	\$250-\$500	K3-75/2
MF2/1-100/2	760721	100mm	\$250-\$500	K3-100/2
MF2/1-150/2	760739	150mm	\$250-\$500	K3-150/2

Chair Raiser Platform

Band 1

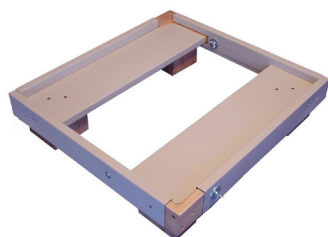

SPECIFICATIONS

Standard Chair
Suits most square shape lounge chairs

SUPPLIER

Multifit Hospital Supplies Ltd

DIMENSIONS

438-816mm adjustable width
528-873mm adjustable length

BRAND

Multifit Hospital Supplies

MAX USER WEIGHT

380kg over 4 feet



SUPPLIER PRODUCT ID	JDE#	HEIGHT	PRICE BREAK	ORDERING CODE
MF1/1-50	760384	50mm	\$50-\$250	K1-50
MF1/1-75	760392	75mm	\$50-\$250	K1-75
MF1/1-100	760368	100mm	\$50-\$250	K1-100
MF1/1-150	760376	150mm	\$50-\$250	K1-150

Whaikaha - Ministry of Disabled People Band 1 List Equipment

Kitchen & Living

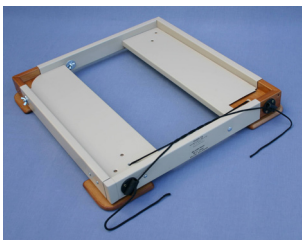

Chair Raiser Platform

Band 1

 		SPECIFICATIONS Big Softie Style Suits most rocking/recliner chairs that have a steel tube base		
SUPPLIER		DIMENSIONS		
Multifit Hospital Supplies Ltd		485-710mm adjustable width 530-885mm adjustable length		
BRAND		MAX USER WEIGHT		
Multifit Hospital Supplies		380kg over 4 feet		
SUPPLIER PRODUCT ID	JDE#	HEIGHT	PRICE BREAK	ORDERING CODE
MF1/7-50	760421	50mm	\$250-\$500	K13-50
MF1/7-75	760430	75mm	\$250-\$500	K13-75
MF1/7-100	760405	100mm	\$250-\$500	K13-100
MF1/7-150	760413	150mm	\$250-\$500	K13-150

Chair Raiser Platform

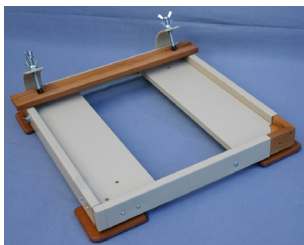
Band 1

 		SPECIFICATIONS Lazy Boy Style Suits LazyBoy style chair which have wooden runners that extend past the rear of the chair base		
SUPPLIER		DIMENSIONS		
Multifit Hospital Supplies Ltd		485-710mm adjustable width 530-885mm adjustable length		
BRAND		MAX USER WEIGHT		
Multifit Hospital Supplies		380kg over 4 feet		
SUPPLIER PRODUCT ID	JDE#	HEIGHT	PRICE BREAK	ORDERING CODE
MF1/3-50	760464	50mm	\$250-\$500	K2-50
MF1/3-75	760472	75mm	\$250-\$500	K2-75
MF1/3-100	760448	100mm	\$250-\$500	K2-100
MF1/3-150	760456	150mm	\$250-\$500	K2-150

Whaikaha - Ministry of Disabled People Band 1 List Equipment

Kitchen & Living

Chair		Band 1	
		SPECIFICATIONS	
		Rehab chair Multi-purpose	
SUPPLIER		DIMENSIONS	
Cubro		430 - 580mm adjustable height 440mm width between arms 430mm seat width 440mm seat depth	
BRAND		MAX USER WEIGHT	
Viking		200kg	
SUPPLIER PRODUCT ID	JDE#	PRICE BREAK	ORDERING CODE
609S	740762	\$250-\$500	K5-U

Whaikaha - Ministry of Disabled People Band 1 List Equipment

Manual Handling

Transfer Board		Band 1	
		SPECIFICATIONS	
		Plastic construction Curved board	
SUPPLIER		DIMENSIONS	
Tastech Services Ltd		660mm long 200mm wide	
BRAND		MAX USER WEIGHT	
Tastech Services		110kg	
SUPPLIER PRODUCT ID	JDE#	PRICE BREAK	ORDERING CODE
TBP2	834312	\$50-\$250	TB68

Transfer Belt		Band 1	
		SPECIFICATIONS	
		Small Orange 7 handles	
SUPPLIER		DIMENSIONS	
USL Medical		600 / 1000mm length	
BRAND		MAX USER WEIGHT	
LIKO		200kg	
SUPPLIER PRODUCT ID	JDE#	PRICE BREAK	ORDERING CODE
L3760014	834304	\$50-\$250	TB1

Transfer Belt		Band 1	
		SPECIFICATIONS	
		Medium Yellow 9 handles	
SUPPLIER		DIMENSIONS	
USL Medical		750 / 1200mm length	
BRAND		MAX USER WEIGHT	
LIKO		200kg	
SUPPLIER PRODUCT ID	JDE#	PRICE BREAK	ORDERING CODE
L3760015	827850	\$50-\$250	TB2

Whaikaha - Ministry of Disabled People Band 1 List Equipment

Manual Handling

Transfer Belt		Band 1	
		SPECIFICATIONS	
		Large Blue 11 handles	
SUPPLIER		DIMENSIONS	
USL Medical		900 / 1400mm length	
BRAND		MAX USER WEIGHT	
LIKO		200kg	
SUPPLIER PRODUCT ID	JDE#	PRICE BREAK	ORDERING CODE
L3760016	826988	\$50-\$250	TB3

Whaikaha - Ministry of Disabled People Band 1 List Equipment

Paediatric

Feeding ADL		Band 1	
		SPECIFICATIONS	
		Haberman feeder 2 teats	
SUPPLIER		DIMENSIONS	
Zabonne		150ml	
BRAND		MAX USER WEIGHT	
		N/A	
SUPPLIER PRODUCT ID	JDE#	PRICE BREAK	ORDERING CODE
FD-HF	796281	\$50-\$250	P152

Accessories

DESCRIPTION	JDE#	SUPPLIER PRODUCT ID	PRICE BREAK	ORDERING CODE
Haberman teat	845396	FD-HT	Under \$50	P153

Feeding ADL		Band 1	
		SPECIFICATIONS	
		Pigeon feeder 2 teats - 1 x large, 1 x small	
SUPPLIER		DIMENSIONS	
Zabonne		240ml	
BRAND		MAX USER WEIGHT	
		N/A	
SUPPLIER PRODUCT ID	JDE#	PRICE BREAK	ORDERING CODE
FD-PB-CP	802556	Under \$50	P167

Accessories

DESCRIPTION	JDE#	SUPPLIER PRODUCT ID	PRICE BREAK	ORDERING CODE
Pigeon teat small	848116	FD-PN-CP	Under \$50	P168
Pigeon teat regular	881629	FD-PN-REG	Under \$50	P171

Whaikaha - Ministry of Disabled People Band 1 List Equipment

Paediatric

Height Adjustable Chair Band 1

	SPECIFICATIONS
	Wooden chair with adjustable seat and footrest

SUPPLIER		DIMENSIONS	
Viking Imports LTD		830x480x560mm	
BRAND		MAX USER WEIGHT	
DanChair		75kg	
SUPPLIER PRODUCT ID	JDE#	PRICE BREAK	ORDERING CODE
DanChair	877427	\$250-\$500	P49

Accessories

DESCRIPTION	JDE#	SUPPLIER PRODUCT ID	PRICE BREAK	ORDERING CODE
Large Tray	877435	DANCHAIR TRAY	\$250-\$500	P154
Seat/Footrest w Large Hip Groin Strap	877443	DANCHAIR LARGE SEAT	\$250-\$500	P155
Platform with Legs	877451	DANCHAIR PLATFORM	\$250-\$500	P156
Note: Platform without Legs must be used in conjunction with Platform with Legs for stability.				
Platform without Legs	884150	DCLGFOOTPLATE/ PLATFORM	\$250-\$500	P172

Whaikaha - Ministry of Disabled People Band 1 List Equipment

Paediatric

Toilet Surround Band 1

		SPECIFICATIONS	
		Toilet Surround	
SUPPLIER		DIMENSIONS	
B M Enterprises		500mm width 600mm depth 525-725mm adjustable height	
BRAND		MAX USER WEIGHT	
		N/A	
SUPPLIER PRODUCT ID	JDE#	PRICE BREAK	ORDERING CODE
BM300	778592	\$250-\$500	P159

Toilet Surround Band 1

		SPECIFICATIONS	
		Toilet Surround with suction cup feet	
SUPPLIER		DIMENSIONS	
B M Enterprises		500mm width 600mm depth 525-725mm adjustable height	
BRAND		MAX USER WEIGHT	
		N/A	
SUPPLIER PRODUCT ID	JDE#	PRICE BREAK	ORDERING CODE
BM300SUC	840755	\$250-\$500	P160

Whaikaha - Ministry of Disabled People Band 1 List Equipment

Paediatric

Bath Support Band 1

		SPECIFICATIONS				
		Wrap-around bath support padded Low back				
SUPPLIER		DIMENSIONS				
Allied Medical		370mm Seat Depth 425mm Seat Width 700mm Length				
BRAND		MAX USER WEIGHT				
Columbia		N/A				
SUPPLIER PRODUCT ID	JDE#	SIZE	BACK HEIGHT RANGE	INSIDE BACK WIDTH	PRICE BREAK	ORDERING CODE
DMBCWL-7210S	738697	Small	225-350mm	212.5mm	\$750-\$1000	P161
DMBCWL-7310M	815058	Medium	250-350mm	312mm	\$750-\$1000	P162
DMBCWL-7410L	845353	Large	270-400mm	362mm	\$750-\$1000	P163

Bath Support Band 1

		SPECIFICATIONS				
		Wrap-around bath support padded High back				
SUPPLIER		DIMENSIONS				
Allied Medical		362mm seat depth 425mm seat width 700mm length				
BRAND		MAX USER WEIGHT				
Columbia		N/A				
SUPPLIER PRODUCT ID	JDE#	SIZE	BACK HEIGHT RANGE	INSIDE BACK WIDTH	PRICE BREAK	ORDERING CODE
DMBCWH-7610S	803031	Small	425-550mm	325mm	\$750-\$1000	P164
DMBCWH-A7710M	738689	Medium	475-600mm	325mm	\$750-\$1000	P165

Whaikaha - Ministry of Disabled People Band 1 List Equipment

Paediatric

Bath Chair

Band 1



SPECIFICATIONS

Shower / bath system with chest strap and cover

SUPPLIER

Medix 21

BRAND

Rifton Blue Wave

DIMENSIONS



SUPPLIER PRODUCT ID	JDE#	SIZE	SEAT DEPTH	SEAT WIDTH	MAX USER WEIGHT	PRICEBREAK	ORDERING CODE
Z211-B	740471	Small	270mm	380mm	34kg	\$750-\$1000	P178
Z221-B	740439	Medium	330mm	380mm	68kg	\$750-\$1000	P79
Z231-B	899941	Large	430mm	430mm	113kg	Over \$1000	P80



Accessories



Description	JDE#	SUPPLIER PRODUCT ID	DIMENSIONS	MAX USER WEIGHT	PRICEBREAK	ORDERING CODE
Tub Stand	740421	Z217	440mm width 140-290mm height adjustable	113kg	\$250-\$500	P81
Shower Stand	800121	Z218	560mm seat to floor height 690mm base width 860mm base length	113kg	Over \$1000	P82

Whaikaha - Ministry of Disabled People Band 1 List Equipment

Shower & Bath

Bath Step		Band 1		
  		SPECIFICATIONS		
		Bath step fixed height Rust Free Aluminium Non slip mat.		
SUPPLIER		DIMENSIONS		
Goldfern Mobility		450x320mm platform size		
BRAND		MAX USER WEIGHT		
Goldfern Mobility		180kg		
SUPPLIER PRODUCT ID	JDE#	HEIGHT	PRICE BREAK	ORDERING CODE
GM-HMP-8334	869806	140mm	\$50-\$250	S1
GM-HMP-8333	869814	140mm with handle	\$50-\$250	S13

Bathboard		Band 1		
 		SPECIFICATIONS		
		Plastic construction		
SUPPLIER		DIMENSIONS		
Allied Medical Ltd		350mm board width		
BRAND		MAX USER WEIGHT		
Maxhealth		200kg		
SUPPLIER PRODUCT ID	JDE#	BOARD LENGTH	PRICE BREAK	ORDERING CODE
MP20301	834321	690x395mm	\$50-\$250	S2
AML20303	834339	740x432mm	\$50-\$250	S4

Transfer Bench		Band 1		
 		SPECIFICATIONS		
		Transfer bench		
SUPPLIER		DIMENSIONS		
Cubro		470-585mm adjustable height 380-490mm bath clearance		
BRAND		MAX USER WEIGHT		
Oakwood		130kg		
SUPPLIER PRODUCT ID	JDE#	PRICE BREAK	ORDERING CODE	
256	739569	\$50-\$250	S16	

© All contents within this document are the copyrighted property of Enable New Zealand. Contents may not be copied, reproduced, modified, published, uploaded, posted, transmitted or distributed in any way without the prior written consent of Enable New Zealand.



Whaikaha - Ministry of Disabled People Band 1 List Equipment



Shower & Bath

Swivel Bather		Band 1		
		SPECIFICATIONS		
		Swivel bather See below for height options		
SUPPLIER		DIMENSIONS		
Cubro		470mm width between arms 700-855mm adjustable base width 420mm back height		
BRAND		MAX USER WEIGHT		
Oakwood		120kg		
SUPPLIER PRODUCT ID	JDE#	HEIGHT	PRICE BREAK	ORDERING CODE
508	762030	Swivel bather	\$250-\$500	S5
508/HA50	762021	Swivel bather with 50mm height adaptor	\$250-\$500	S5-50
508/HA100	762013	Swivel bather with 100mm height adaptor	\$250-\$500	S5-100

Whaikaha - Ministry of Disabled People Band 1 List Equipment

Shower & Bath



Shower Stool		Band 1	
 		SPECIFICATIONS	
		Shower stool without arms	
SUPPLIER		DIMENSIONS	
Goldfern Mobility		490-610mm adjustable height 285x380mm seat size	
BRAND		MAX USER WEIGHT	
Goldfern Mobility		170kg	
SUPPLIER PRODUCT ID	JDE#	PRICE BREAK	ORDERING CODE
GM-HMP-792	833150	\$50-\$250	S8-NA



Shower Stool		Band 1	
 		SPECIFICATIONS	
		Shower stool with arms	
SUPPLIER		DIMENSIONS	
Goldfern Mobility		470mm width between arms 490-610mm adjustable height	
BRAND		MAX USER WEIGHT	
Goldfern Mobility		170kg	
SUPPLIER PRODUCT ID	JDE#	PRICE BREAK	ORDERING CODE
GM-HMP-792A	833168	\$50-\$250	S8-A



Shower Chair		Band 1	
		SPECIFICATIONS	
		Shower chair without arms	
SUPPLIER		DIMENSIONS	
Goldfern Mobility		490-640mm adjustable height	
BRAND		MAX USER WEIGHT	
Goldfern Mobility		110kg	
SUPPLIER PRODUCT ID	JDE#	PRICE BREAK	ORDERING CODE
GM-HMP-792L	833272	\$50-\$250	S10-NA

Whaikaha - Ministry of Disabled People Band 1 List Equipment

Shower & Bath

Shower Chair		Band 1	
 		SPECIFICATIONS Shower chair with arms	
SUPPLIER		DIMENSIONS	
Goldfern Mobility		490mm width between arms 490-640mm adjustable height	
BRAND		MAX USER WEIGHT	
Goldfern Mobility		110kg	
SUPPLIER PRODUCT ID	JDE#	PRICE BREAK	ORDERING CODE
GM-HMP-792LA	833281	\$50-\$250	S10-A

Shower Chair		Band 1	
 		SPECIFICATIONS Shower chair maxi with arms	
SUPPLIER		DIMENSIONS	
Cubro		500mm width between arms 420-550mm adjustable height	
BRAND		MAX USER WEIGHT	
Viking		200kg	
SUPPLIER PRODUCT ID	JDE#	PRICE BREAK	ORDERING CODE
336M500	740981	\$50-\$250	S19-A

Shower Commode Chair		Band 1	
 		SPECIFICATIONS Closed seat Bariatric	
SUPPLIER		DIMENSIONS	
Allied Medical Ltd		430-580mm adjustable height 610mm seat width 430mm seat depth	
BRAND		MAX USER WEIGHT	
Drive		280kg	
SUPPLIER PRODUCT ID	JDE#	PRICE BREAK	ORDERING CODE
DM190	834371	\$500-\$750	BA24

Whaikaha - Ministry of Disabled People Band 1 List Equipment

Shower & Bath



Shower Commode		Band 1	
		SPECIFICATIONS	
		Transit wheels Soft seat with keyhole opening Adjustable seat height Adjustable leg rests Pan with lid and carrier included	
SUPPLIER		DIMENSIONS	
Invacare New Zealand		480mm seat width 450mm seat depth	
BRAND		MAX USER WEIGHT	
Aquatec		150kg	
SUPPLIER PRODUCT ID	JDE#	PRICE BREAK	ORDERING CODE
PKG-1643718	898498	\$500-\$750	S110



Shower Commode		Band 1	
		SPECIFICATIONS	
		Self-propelling Seat options below	
SUPPLIER		DIMENSIONS	
Cubro		430mm seat width 430mm seat depth	
BRAND		MAX USER WEIGHT	
Juvo Viking		160kg	
SUPPLIER PRODUCT ID	JDE#	PRICE BREAK	ORDERING CODE
2348U	853951	Over \$1000	S12



Accessories				
DESCRIPTION	JDE#	SUPPLIER PRODUCT ID	PRICE BREAK	ORDERING CODE
Closed seat	840747	75PC/75PR-FITTED	\$50-\$250	PA29
Open seat	833660	75PO/75PR-FITTED	\$50-\$250	PA22
Pan carrier & Bedpan	840499	2359/75P	\$50-\$250	PA23
Bowl with lid and carrier	840501	2359/325	\$50-\$250	PA24

Whaikaha - Ministry of Disabled People Band 1 List Equipment

Toileting

Toilet Seat					Band 1
 		SPECIFICATIONS			
		Raised toilet seat\			
SUPPLIER		DIMENSIONS			
AT Therapy Limited		385mm depth 350mm width			
BRAND		MAX USER WEIGHT			
Patterson's		190kg			
SUPPLIER PRODUCT ID	JDE#	HEIGHT	PRICE BREAK	ORDERING CODE	
AA2112	759834	50mm	\$50-\$250	T5-50	
AA2114Y	759851	100mm	\$50-\$250	T5-100	

Toilet Seat					Band 1
 		SPECIFICATIONS			
		Raised toilet seat			
SUPPLIER		DIMENSIONS			
Cubro		390mm depth 360mm width			
BRAND		MAX USER WEIGHT			
ETAC		150kg			
SUPPLIER PRODUCT ID	JDE#	HEIGHT	PRICE BREAK	ORDERING CODE	
5450	760000	60mm	\$50-\$250	T8-60	
5451	759990	100mm	\$50-\$250	T8-100	

Toilet Seat					Band 1
 		SPECIFICATIONS			
		Raised toilet seat 150mm			
SUPPLIER		DIMENSIONS			
Allied Medical Ltd		360mm width 410mm depth 150mm height			
BRAND		MAX USER WEIGHT			
Drive		200kg			
SUPPLIER PRODUCT ID	JDE#	PRICE BREAK	ORDERING CODE		
DM12066	834072	\$50-\$250	T8-150		

Whaikaha - Ministry of Disabled People Band 1 List Equipment

Toileting

Toilet Surround Band 1

 		SPECIFICATIONS	
		Freestanding toilet frame	
SUPPLIER		DIMENSIONS	
Goldfern Mobility		440-640mm adjustable width	
BRAND		MAX USER WEIGHT	
Goldfern Mobility		120kg	
SUPPLIER PRODUCT ID	JDE#	PRICE BREAK	ORDERING CODE
GM-HMP-8109	872634	\$50-\$250	T4

Accessories



DESCRIPTION	JDE#	SUPPLIER PRODUCT ID	PRICE BREAK	ORDERING CODE
Suction Feet Pair	884168	GMP-HMP-8109TIP-S	Under \$50	T33



Toilet Surround Band 1



		SPECIFICATIONS	
		Toilet surround	
SUPPLIER		DIMENSIONS	
Cubro		650-750mm adjustable floor- arm height 450-550mm between arm width	
BRAND		MAX USER WEIGHT	
Oakwood		100kg	
SUPPLIER PRODUCT ID	JDE#	PRICE BREAK	ORDERING CODE
228	773732	\$50-\$250	T10

Whaikaha - Ministry of Disabled People Band 1 List Equipment

Toileting

Toilet Frame		Band 1	
 		SPECIFICATIONS Over-toilet frame Supplied with splash guard	
SUPPLIER		DIMENSIONS	
Cubro		480-620mm adjustable height 445mm between arm width	
BRAND		MAX USER WEIGHT	
Viking		150kg	
SUPPLIER PRODUCT ID	JDE#	PRICE BREAK	ORDERING CODE
390	753379	\$50-\$250	T3

Commode		Band 1	
 		SPECIFICATIONS 3 in 1 commode	
SUPPLIER		DIMENSIONS	
Allied Medical Ltd		580mm overall length 450mm overall width 430mm overall depth 405-560mm adjustable height	
BRAND		MAX USER WEIGHT	
Maxhealth		113kg	
SUPPLIER PRODUCT ID	JDE#	PRICE BREAK	ORDERING CODE
AML20505	834380	\$50-\$250	T2

Commode		Band 1	
 		SPECIFICATIONS Bedside commode	
SUPPLIER		DIMENSIONS	
Cubro		480-600mm adjustable seat height 440mm seat width 440mm seat depth	
BRAND		MAX USER WEIGHT	
Viking		120kg	
SUPPLIER PRODUCT ID	JDE#	PRICE BREAK	ORDERING CODE
565	741221	\$50-\$250	T1

Whaikaha - Ministry of Disabled People Band 1 List Equipment

Wheelchairs & Seating

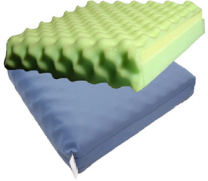
Cushion					Band 1
			DESCRIPTION		
			Komfit Cushion		
SUPPLIER			ASSESSOR ACCREDITATION		
Permobil			WMPML1, WMPML1P, WMPML2, WMPML2P		
BRAND			MAX USER WEIGHT		
Komfit			95 kg		
SUPPLIER PRODUCT ID	JDE#	SIZE (width x depth)	PRICE BREAK	ORDERING CODE	
CU499	911648	12x12	\$50-\$250	CU289	
CU500	747825	14x14	\$50-\$250	CU17	
CU502	747876	16x16	\$50-\$250	CU18	
CU505	747884	18x18	\$50-\$250	CU21	

Cushion					Band 1
			DESCRIPTION		
			System France Cushion		
SUPPLIER			ASSESSOR ACCREDITATION		
Morton & Perry			WMPML1, WMPML1P, WMPML2, WMPML2P		
BRAND			MAX USER WEIGHT		
System France					
SUPPLIER PRODUCT ID	JDE#	SIZE (width x depth)	PRICE BREAK	ORDERING CODE	
XP371CB	911656	12x12	\$50-\$250	CU290	
XP371CC	911664	14x14	\$50-\$250	CU291	
XP371C	834099	16x16	\$50-\$250	CU24	
XP371L	834128	18x18	\$50-\$250	CU30	

Whaikaha - Ministry of Disabled People Band 1 List Equipment

Wheelchairs & Seating

Wheelchair Paediatric Folding Frame - Standard Non-adjustable

Band 1

		SPECIFICATIONS		
		Swing away removeable footrests Anti-tips Push to lock brakes Lap belt Adjustable height attendant handles Adjustable arm pads Removable arm rests Nylon seat fabric Removeable/washable base and back cover		
SUPPLIER		ASSESSOR ACCREDITATION		
Goldfern Mobilty		WMPML1, WMPML1P, WMPML2, WMPML2P		
BRAND		MAX USER WEIGHT		
Goldfern Mobility Junior		150kg		
SUPPLIER PRODUCT ID	JDE#	SIZE	PRICE BREAK	ORDERING CODE
GM-AST-JNRSP-1212	902434	12x12	\$500-\$750	WC337
GM-AST-JNRSP-1414	902442	14x14	\$500-\$750	WC338

Wheelchair Manual

Band 1

		SPECIFICATIONS		
		Transit wheelchair Swing in/away and height adjustable footrests Lap belt Anti-tippers Adjustable and removable arms		
SUPPLIER		ASSESSOR ACCREDITATION		
Goldfern Mobility		WMPML1, WMPML1P, WMPML2, WMPML2P		
BRAND		MAX USER WEIGHT		
Goldfern Mobility		127kg		
SUPPLIER PRODUCT ID	JDE#	SIZE	PRICE BREAK	ORDERING CODE
GME-AST-EUT1616	856141	16x16"	\$500-\$750	WC77
GME-AST-EUT1818	856159	18x18"	\$500-\$750	WC78

Whaikaha - Ministry of Disabled People Band 1 List Equipment

Wheelchairs & Seating

Wheelchair Manual				Band 1	
		SPECIFICATIONS			
		Self propelling wheelchair Swing in/away and height adjustable footrests Lap belt Anti-tippers Adjustable and removable arms			
SUPPLIER		ASSESSOR ACCREDITATION			
Goldfern Mobility		WMPML1, WMPML1P, WMPML2, WMPML2P			
BRAND		MAX USER WEIGHT			
Goldfern Mobility		127kg			
SUPPLIER PRODUCT ID	JDE#	SIZE	PRICE BREAK	ORDERING CODE	
GME-AST-EUSP1616	856124	16x16"	\$500-\$750	WC75	
GME-AST-EUSP1818	856132	18x18"	\$500-\$750	WC76	

Ramp				Band 1	
		SPECIFICATIONS			
		Aluminium ramp with non-skid surface			
SUPPLIER		DIMENSIONS			
Cubro					
BRAND		MAX USER WEIGHT			
EuroRamps		267kg			
SUPPLIER PRODUCT ID	JDE#	SIZE	PRICE BREAK	ORDERING CODE	
547	761117	25mm H x 125mm L x 850mm W	\$250-\$500	RA14	
548	761301	50mm H x 250mm L x 850mm W	\$50-\$250	RA171	
549	761310	75mm H x 375mm L x 850mm W	\$250-\$500	RA172	

Whaikaha - Ministry of Disabled People Band 1 List Equipment

Products under \$50

Equipment under the value of \$50 (GST inc) will not be provided unless:

- the person is living in residential care is under 65 and who has a lifelong disability.
- the person is unable to pay due to hardship and is receiving either a Special Benefit or Temporary Additional Support from Work and Income. Written confirmation from Work and Income is required to support the application.
- the person is under 16 years old.

NB – all relevant eligibility criteria must also be met.

Elbow Crutch		Band 1	
		SPECIFICATIONS	
		Junior forearm crutch Height adjustable Pair	
SUPPLIER		DIMENSIONS	
Allied Medical		457-656mm adjustable height	
BRAND		MAX USER WEIGHT	
Allied Medical		100kg	
SUPPLIER PRODUCT ID	JDE#	PRICE BREAK	ORDERING CODE
SMBE1070	880781	Under \$50	P35

Elbow Crutch		Band 1		
		SPECIFICATIONS		
		Double adjustable - anatomical grip - Pair		
SUPPLIER		DIMENSIONS		
Cubro		203-280mm adjustable height armband to grip 686-940mm adjustable height handgrip to ground		
BRAND		MAX USER WEIGHT		
Coopers		127kg		
SUPPLIER PRODUCT ID	Description	JDE#	PRICE BREAK	ORDERING CODE
1741	Pair	745483	Under \$50	C5

Whaikaha - Ministry of Disabled People Band 1 List Equipment

Products under \$50

Equipment under the value of \$50 (GST inc) will not be provided unless:

- the person is living in residential care is under 65 and who has a lifelong disability.
- the person is unable to pay due to hardship and is receiving either a Special Benefit or Temporary Additional Support from Work and Income. Written confirmation from Work and Income is required to support the application.
- the person is under 16 years old.

NB – all relevant eligibility criteria must also be met.

Elbow Crutch		Band 1	
		SPECIFICATIONS	
		Double adjustable Pair	
SUPPLIER		DIMENSIONS	
Cubro		200-270mm adjustable height armband to grip 670-920mm adjustable height handgrip to ground	
BRAND		MAX USER WEIGHT	
Coopers		180kg	
SUPPLIER PRODUCT ID	JDE#	PRICE BREAK	ORDERING CODE
1742	745395	Under \$50	C14

Quad Stick		Band 1			
		SPECIFICATIONS			
		Four point / pronged base Swan neck			
SUPPLIER		DIMENSIONS			
Allied Medical Ltd		730-960mm Adjustable height			
BRAND		MAX USER WEIGHT			
Allied Medical Ltd		110kg			
SUPPLIER PRODUCT ID	JDE#	SIZE	BASE	PRICE BREAK	ORDERING CODE
MP10501K	773679	Small	127x178mm	Under \$50	Q2
MP10502K	773661	Large	178x279mm	Under \$50	Q1

Whaikaha - Ministry of Disabled People Band 1 List Equipment

Products under \$50

Equipment under the value of \$50 (GST inc) will not be provided unless:

- the person is living in residential care is under 65 and who has a lifelong disability.
- the person is unable to pay due to hardship and is receiving either a Special Benefit or Temporary Additional Support from Work and Income. Written confirmation from Work and Income is required to support the application.
- the person is under 16 years old.

NB – all relevant eligibility criteria must also be met.

Walking Stick		Band 1	
		SPECIFICATIONS	
		Swan neck	
SUPPLIER		DIMENSIONS	
Cubro		760-995mm adjustable height	
BRAND		MAX USER WEIGHT	
Swan		127kg	
SUPPLIER PRODUCT ID	JDE#	PRICE BREAK	ORDERING CODE
1706	766840	Under \$50	WS1

Walking Stick		Band 1	
		SPECIFICATIONS	
		Crook handle	
SUPPLIER		DIMENSIONS	
Cubro		760-995mm adjustable height	
BRAND		MAX USER WEIGHT	
Crook		127kg	
SUPPLIER PRODUCT ID	JDE#	PRICE BREAK	ORDERING CODE
1704BL	766591	Under \$50	WS2

Whaikaha - Ministry of Disabled People Band 1 List Equipment

Products under \$50

Equipment under the value of \$50 (GST inc) will not be provided unless:

- the person is living in residential care is under 65 and who has a lifelong disability.
- the person is unable to pay due to hardship and is receiving either a Special Benefit or Temporary Additional Support from Work and Income. Written confirmation from Work and Income is required to support the application.
- the person is under 16 years old.

NB – all relevant eligibility criteria must also be met.

Walking Stick		Band 1	
		SPECIFICATIONS	
		Swan Neck - contour foot	
SUPPLIER		DIMENSIONS	
Cubro		760-995mm adjustable height	
BRAND		MAX USER WEIGHT	
Swan / Contour Foot		127kg	
SUPPLIER PRODUCT ID	JDE#	PRICE BREAK	ORDERING CODE
1706/1757	773652	Under \$50	WS4

Whaikaha - Ministry of Disabled People Band 1 List Equipment

Products under \$50

Equipment under the value of \$50 (GST inc) will not be provided unless:

- the person is living in residential care is under 65 and who has a lifelong disability.
- the person is unable to pay due to hardship and is receiving either a Special Benefit or Temporary Additional Support from Work and Income. Written confirmation from Work and Income is required to support the application.
- the person is under 16 years old.

NB – all relevant eligibility criteria must also be met.

Backrest		Band 1	
		SPECIFICATIONS	
		Manual option Webbed back rest	
SUPPLIER		DIMENSIONS	
Goldfern Mobility			
BRAND		MAX USER WEIGHT	
Goldfern Mobility		N/A	
SUPPLIER PRODUCT ID	JDE#	PRICE BREAK	ORDERING CODE
GMW-YCH-8001	848124	Under \$50	B8

Bed Cradle		Band 1	
		SPECIFICATIONS	
		Bed cradle	
SUPPLIER		DIMENSIONS	
Cubro		475mm height 470mm length 320mm width	
BRAND		MAX USER WEIGHT	
Viking		N/A	
SUPPLIER PRODUCT ID	JDE#	PRICE BREAK	ORDERING CODE
283	738881	Under \$50	B6

Whaikaha - Ministry of Disabled People Band 1 List Equipment

Products under \$50

Equipment under the value of \$50 (GST inc) will not be provided unless:

- the person is living in residential care is under 65 and who has a lifelong disability.
- the person is unable to pay due to hardship and is receiving either a Special Benefit or Temporary Additional Support from Work and Income. Written confirmation from Work and Income is required to support the application.
- the person is under 16 years old.

NB – all relevant eligibility criteria must also be met.

Mug		Band 1	
		SPECIFICATIONS	
		Clear caring mug	
SUPPLIER		DIMENSIONS	
AT Therapy Limited		300ml	
BRAND		MAX USER WEIGHT	
		N/A	
SUPPLIER PRODUCT ID	JDE#	PRICE BREAK	ORDERING CODE
AD3131	784773	Under \$50	K79

Cutlery		Band 1	
		SPECIFICATIONS	
		Supergrip bendable set of 4	
SUPPLIER		DIMENSIONS	
At Therapy Ltd			
BRAND		MAX USER WEIGHT	
Supergrip		N/A	
SUPPLIER PRODUCT ID	JDE#	PRICE BREAK	ORDERING CODE
ATUS-A703209	766399	Under \$50	K82

Whaikaha - Ministry of Disabled People Band 1 List Equipment

Products under \$50

Equipment under the value of \$50 (GST inc) will not be provided unless:

- the person is living in residential care is under 65 and who has a lifelong disability.
- the person is unable to pay due to hardship and is receiving either a Special Benefit or Temporary Additional Support from Work and Income. Written confirmation from Work and Income is required to support the application.
- the person is under 16 years old.

NB – all relevant eligibility criteria must also be met.

Paediatric Cutlery

Band 1

		SPECIFICATIONS		
		Junior Cutlery		
SUPPLIER		DIMENSIONS		
At Therapy				
BRAND		MAX USER WEIGHT		
		N/A		
SUPPLIER PRODUCT ID	JDE#	SPECIFICATIONS	PRICE BREAK	ORDERING CODE
ATUK-AA5575	892934	Knife	Under \$50	P175
ATUK-AA5576	892942	Fork	Under \$50	P176
ATUK-AA5577	892951	Spoon	Under \$50	P177

Paediatric Cutlery

Band 1

		SPECIFICATIONS		
		Caring Cutlery		
SUPPLIER		DIMENSIONS		
At Therapy				
BRAND		MAX USER WEIGHT		
		N/A		
SUPPLIER PRODUCT ID	JDE#	SPECIFICATIONS	PRICE BREAK	ORDERING CODE
ATUK-AA5570	924131	Knife	Under \$50	P179
ATUK-AA5571	924140	Fork	Under \$50	P180
ATUK-AA5572	924158	Spoon	Under \$50	P181
ATUK-AA573R	924166	Right Angle Spoon	Under \$50	P182

Whaikaha - Ministry of Disabled People Band 1 List Equipment

Products under \$50

Equipment under the value of \$50 (GST inc) will not be provided unless:

- the person is living in residential care is under 65 and who has a lifelong disability.
- the person is unable to pay due to hardship and is receiving either a Special Benefit or Temporary Additional Support from Work and Income. Written confirmation from Work and Income is required to support the application.
- the person is under 16 years old.

NB – all relevant eligibility criteria must also be met.

Plate					Band 1
			SPECIFICATIONS		
			Manoy		
SUPPLIER			DIMENSIONS		
AT Therapy Limited					
BRAND			MAX USER WEIGHT		
			N/A		
SUPPLIER PRODUCT ID	JDE#	SIZE	PRICE BREAK	ORDERING CODE	
AD3127	805204	Small	Under \$50	K85	
AD3126	777389	Large	Under \$50	K86	

Slide Sheet				Band 1
			SPECIFICATIONS	
			Transfer sheet Polyester	
SUPPLIER			DIMENSIONS	
Multifit Hospital Supplies LTD			1x1.5m	
BRAND			MAX USER WEIGHT	
			N/A	
SUPPLIER PRODUCT ID	JDE#	PRICE BREAK	ORDERING CODE	
MF SS_AMS 1	834291	Under \$50	TB69	

Whaikaha - Ministry of Disabled People Band 1 List Equipment

Products under \$50

Equipment under the value of \$50 (GST inc) will not be provided unless:

- the person is living in residential care is under 65 and who has a lifelong disability.
- the person is unable to pay due to hardship and is receiving either a Special Benefit or Temporary Additional Support from Work and Income. Written confirmation from Work and Income is required to support the application.
- the person is under 16 years old.

NB – all relevant eligibility criteria must also be met.

Urinal		Band 1	
		SPECIFICATIONS	
		Male non-spill urinal High quality plastic urinal bottle with easy to hold handle Autoclaveable to 135°C	
SUPPLIER		DIMENSIONS	
Cubro		500ml capacity	
BRAND		MAX USER WEIGHT	
Plaspro		N/A	
SUPPLIER PRODUCT ID	JDE#	PRICE BREAK	ORDERING CODE
212	766372	Under \$50	T6

Urinal		Band 1	
		SPECIFICATIONS	
		Female non-spill urinal High quality plastic urinal bottle with easy to hold handle Autoclaveable to 135°C	
SUPPLIER		DIMENSIONS	
Cubro		500ml capacity	
BRAND		MAX USER WEIGHT	
Plaspro		N/A	
SUPPLIER PRODUCT ID	JDE#	PRICE BREAK	ORDERING CODE
212/D	766364	Under \$50	T6-F

Whaikaha - Ministry of Disabled People Band 1 List Equipment

Products under \$50

Equipment under the value of \$50 (GST inc) will not be provided unless:

- the person is living in residential care is under 65 and who has a lifelong disability.
- the person is unable to pay due to hardship and is receiving either a Special Benefit or Temporary Additional Support from Work and Income. Written confirmation from Work and Income is required to support the application.
- the person is under 16 years old.

NB – all relevant eligibility criteria must also be met.

Reacher				Band 1
		SPECIFICATIONS		
		Reacher Magnetic tip		
SUPPLIER		DIMENSIONS		
Allied Medical Ltd				
BRAND		MAX USER WEIGHT		
		N/A		
SUPPLIER PRODUCT ID	JDE#	LENGTH	PRICE BREAK	ORDERING CODE
MP30801	761336	600mm	Under \$50	K10-26
MP30802	761344	750mm	Under \$50	K10-32

Whaikaha - Ministry of Disabled People Band 2 & 3 List Equipment

Table of Contents

Ambulatory Mobility	55
Bedroom	59
Kitchen & Living	68
Manual Handling	69
Patient Lifters	70
Shower & Bath	75
Toileting	80
Wheelchairs & Seating	81

Whaikaha - Ministry of Disabled People Band 2 & 3 List Equipment

Ambulatory Mobility

Crutches		Band 2	
		SPECIFICATIONS	
		Each Bariatric	
SUPPLIER		DIMENSIONS	
Tubular Equipment		980 - 1230mm adjustable height 175x125mm trough dimension	
BRAND		MAX USER WEIGHT	
Tubular Equipment		250kg	
SUPPLIER PRODUCT ID	JDE#	PRICE BREAK	ORDERING CODE
GCHD8	834419	\$250-\$500	BA9

Walking Frame		Band 2		
		SPECIFICATIONS		
SUPPLIER		DIMENSIONS		
Tubular Equipment		400 - 560mm adjustable height 440mm width		
BRAND		MAX USER WEIGHT		
Tiny Tot		70kg		
SUPPLIER PRODUCT ID	JDE#	SPECIFICATIONS	PRICE BREAK	ORDERING CODE
TT1302G	766524	2 wheels, 2 glide feet	\$500-\$1000	P42
TT1307C	746507	2 castors, 2 wheels	\$500-\$1000	P41
Accessories				
DESCRIPTION	JDE#	SUPPLIER PRODUCT ID	PRICE BREAK	ORDERING CODE
Basket	841504	BSK 98	Under \$50	PA28

Whaikaha - Ministry of Disabled People Band 2 & 3 List Equipment

Ambulatory Mobility

Walking Frame Band 2

		SPECIFICATIONS		
SUPPLIER		DIMENSIONS		
Tubular Equipment		460 - 750mm adjustable height 390mm width inside back legs		
BRAND		MAX USER WEIGHT		
Junior Rover		100kg		
SUPPLIER PRODUCT ID	JDE#	SPECIFICATIONS	PRICE BREAK	ORDERING CODE
JR102G	808544	2 wheels, 2 glide feet	\$500-\$750	P37
JR107C	810644	2 castors, 2 wheels	\$500-\$750	P22

Accessories

DESCRIPTION	JDE#	SUPPLIER PRODUCT ID	PRICE BREAK	ORDERING CODE
Basket/Tray	830400	BSKT 88	\$50-\$250	PA26

Walking Frame Band 2

		SPECIFICATIONS				
		Mustang				
SUPPLIER		DIMENSIONS				
Euromedical Ltd						
BRAND						
R82 of Denmark						
SUPPLIER PRODUCT ID	JDE#	SIZE	CHEST PAD HEIGHT	MAX USER WEIGHT	PRICE BREAK	ORDERING CODE
R82-869011	826494	1	650mm	30kg	\$3000-\$3500	WF78
R82-869021	832190	2	800mm	40kg	\$3000-\$3500	WF79

Whaikaha - Ministry of Disabled People Band 2 & 3 List Equipment

Ambulatory Mobility

Standing Frame				Band 2			
				SPECIFICATIONS			
				Totstander			
SUPPLIER				DIMENSIONS			
Allied Medical Ltd				470 - 640mm chest pad height 450mm base width x 450mm base height			
BRAND				MAX USER WEIGHT			
Leckey				20kg			
SUPPLIER PRODUCT ID		JDE#		PRICE BREAK		ORDERING CODE	
LKLFS/T-MW		764369		\$2500-\$3000		P83	

Standing Frame				Band 3			
				SPECIFICATIONS			
				Freestanding			
SUPPLIER				DIMENSIONS			
Allied Medical Ltd							
BRAND							
Leckey							
SUPPLIER PRODUCT ID	JDE#	Size	CHEST PAD HEIGHT	BASE	MAX USER WEIGHT	PRICE BREAK	ORDERING CODE
LKLFS/1-MW-EXP	764220	1	526 - 851mm	650x650mm	60kg	\$3500-\$4000	P63
LKLFS/2-MB-EXP	764238	2	681 - 1100mm	750x750mm	80kg	\$3500-\$4000	P64
LKLFS/3-MB-EXP	764246	3	975 - 1425mm	750x750mm	90kg	\$3500-\$4000	P65

Whaikaha - Ministry of Disabled People Band 2 & 3 List Equipment

Ambulatory Mobility

Standing Frame				Band 2			
				SPECIFICATIONS			
				Toucan			
SUPPLIER				DIMENSIONS			
Euromedical Ltd							
BRAND							
R82 of Denmark							
SUPPLIER PRODUCT ID	JDE#	Size	WIDTH	ADJUSTABLE HEIGHT	MAX USER WEIGHT	PRICE BREAK	ORDERING CODE
R82-861001	788782	1	560mm	340 - 700mm	30kg	\$3000-\$3500	P58
R82-861002	802919	2	630mm	540 - 900mm	40kg	\$3000-\$3500	P59
R82-861003	808958	3	630mm	740 - 1100mm	50kg	\$3000-\$3500	P60
R82-861004	815023	4	700mm	910 - 1210mm	60kg	\$3000-\$3500	P61
R82-861005	835139	5	700mm	1110 - 1410mm	70kg	\$3000-\$3500	P84

Whaikaha - Ministry of Disabled People Band 2 & 3 List Equipment

Bedroom

Overbed Table		Band 2	
		SPECIFICATIONS	
		Tilt top H Base Split Top	
SUPPLIER		DIMENSIONS	
Allied Medical Ltd		410x610mm top size 720-1150mm adjustable height	
BRAND		MAX USER WEIGHT	
Maxhealth		N/A	
SUPPLIER PRODUCT ID	JDE#	PRICE BREAK	ORDERING CODE
MP30203	828431	\$50-\$250	B29

Whaikaha - Ministry of Disabled People Band 2 & 3 List Equipment

Bedroom

Bed Electric Band 2

		SPECIFICATIONS	
		Bed electric Trendelenberg See accessory options below	
SUPPLIER		DIMENSIONS	
Cubro		2000mm inside length 900mm inside width 390-800mm height adjustment	
BRAND		MAX SWL	MAX CLIENT WEIGHT
Bock Domiflex "Push and Ready"		190kg	155kg
SUPPLIER PRODUCT ID	JDE#	PRICE BREAK	ORDERING CODE
912/WAT	876221	\$1000-\$1500	B11

Accessories

DESCRIPTION	JDE#	SUPPLIER PRODUCT ID	SPECIFICATIONS	PRICE BREAK	ORDERING CODE
3/4 length side left	810177	910T-L	Folding	\$50-\$250	B13L
3/4 length side right	810185	910T-R	Folding	\$50-\$250	B13R
3/4 length side cover (each)	758381	PS910T	Vinyl padded	\$50-\$250	B16
Full length side left	876230	SR912 - S	Drop down	\$50-\$250	B264L
Full length side right	876248	SR912 - S	Drop down	\$50-\$250	B264R
Full length side cover (each)	786656	5115	Vinyl padded	\$50-\$250	B266
Extension kit 20cm	876256	EL912	Including bolster	\$250-\$500	B253
Full length sides cannot be used with the extension kit please use Extra Long Full length sides					
Extra long Full length side left	880010	SR912EL - S	Drop down	\$250-\$500	B277L
Extra long Full length side right	880028	SR912EL - S	Drop down	\$250-\$500	B277R
Self help pole	808317	5113		\$50-\$250	B14
Side Support Rail	841491	5109-2		\$50-\$250	B18

Mattress

Band 2

		SPECIFICATIONS	
		Medi Flex Castellated Foam Mattress Single	
SUPPLIER		DIMENSIONS	
Cubro		1980x900x150mm	
BRAND		MAX USER WEIGHT	
MediFlex		N/A	
SUPPLIER PRODUCT ID	JDE#	PRICE BREAK	ORDERING CODE
1660	844326	\$500-\$750	B12

Whaikaha - Ministry of Disabled People Band 2 & 3 List Equipment

Bedroom

Bed Electric Ultra Low Band 3

		SPECIFICATIONS	
		Bed electric ultra low Trendelenberg See accessory options below	
SUPPLIER		DIMENSIONS	
Cubro		2000mm inside length 900mm inside width 210-640mm height adjustment	
BRAND		MAX SWL	MAX CLIENT WEIGHT
Bock Domiflex Classic Ultra Low		170kg	135kg
SUPPLIER PRODUCT ID	JDE#	PRICE BREAK	ORDERING CODE
915/WA	857258	\$1500-\$2000	B274

Accessories

DESCRIPTION	JDE#	SUPPLIER PRODUCT ID	SPECIFICATIONS	PRICE BREAK	ORDERING CODE
3/4 length side left	810177	910T-L	Folding	\$50-\$250	B13L
3/4 length side right	810185	910T-R	Folding	\$50-\$250	B13R
3/4 length side cover (each)	758381	PS910T	Vinyl padded	\$50-\$250	B16
Full length side left	857266	SR915-S	Drop down	\$50-\$250	B267L
Full length side right	857282	SR915-S	Drop down	\$50-\$250	B267R
Full length side cover (each)	786656	5115	Vinyl padded	\$50-\$250	B266
Extension kit 20cm	801836	5066	Including bolster	\$250-\$500	B269
Full length sides cannot be used with the extension kit please use Extra Long Full length sides					
Extra long Full length side left	880052	SR915EL-S	Drop down	\$250-\$500	B278L
Extra long Full length side right	880061	SR915EL-S	Drop down	\$250-\$500	B278R
Self help pole	808317	5113		\$50-\$250	B14
Side Support Rail	841491	5109		\$50-\$250	B18

Mattress Band 2

		SPECIFICATIONS	
		Medi Flex Castellated Foam Mattress Single	
SUPPLIER		DIMENSIONS	
Cubro		1980x900x150mm	
BRAND		MAX USER WEIGHT	
MediFlex		120kg	
SUPPLIER PRODUCT ID	JDE#	PRICE BREAK	ORDERING CODE
1660	844326	\$250-\$500	B12

© All contents within this document are the copyrighted property of Enable New Zealand. Contents may not be copied, reproduced, modified, published, uploaded, posted, transmitted or distributed in any way without the prior written consent of Enable New Zealand.

Whaikaha - Ministry of Disabled People Band 2 & 3 List Equipment

Bedroom

Bed Electric King Single Band 3

		SPECIFICATIONS	
		Bed electric super single Trendelenberg See accessory options below	
SUPPLIER		DIMENSIONS	
Cubro		2000mm inside length 1100mm inside width 250-800mm height adjustment	
BRAND		MAX SWL	MAX CLIENT WEIGHT
Bock Practico Lie Low Extra Wide		220kg	185kg
SUPPLIER PRODUCT ID	JDE#	PRICE BREAK	ORDERING CODE
947/WA	867392	\$4500-\$5000	B275

Accessories

DESCRIPTION	JDE#	SUPPLIER PRODUCT ID	SPECIFICATIONS	PRICE BREAK	ORDERING CODE
3/4 length side left	810177	910T-L	Folding	\$50-\$250	B13L
3/4 length side right	810185	910T-R	Folding	\$50-\$250	B13R
3/4 length side cover (each)	758381	PS910T	Vinyl padded	\$50-\$250	B16
Full length side left	802231	SR920-S	Drop down	\$50-\$250	B270L
Full length side right	802249	SR920-S	Drop down	\$50-\$250	B270R
Full length side cover (each)	786656	5115	Vinyl padded	\$50-\$250	B266
Extension kit	846129	5067	Including mattress	\$250-\$500	B272
Full length sides cannot be used with the extension kit please use Extra Long Full length sides					
Extra long Full length side left	880079	SR920EL-S	Drop down	\$250-\$500	B279L
Extra long Full length side right	880087	SR920EL-S	Drop down	\$250-\$500	B279R
Self help pole	808317	5113		\$50-\$250	B14
Side Support Rail	841491	5109		\$50-\$250	B18

Mattress Band 3

		SPECIFICATIONS	
		Medi Flex Castellated Foam Mattress Super Single	
SUPPLIER		DIMENSIONS	
Cubro		1980x1100x150mm	
BRAND		MAX USER WEIGHT	
MediFlex		120kg	
SUPPLIER PRODUCT ID	JDE#	PRICE BREAK	ORDERING CODE
1661	852449	\$750-\$1000	B273

Whaikaha - Ministry of Disabled People Band 2 & 3 List Equipment

Bedroom

Bed Electric Bariatric

Band 3

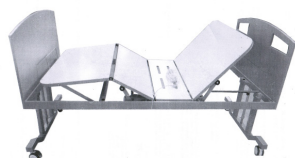

SPECIFICATIONS

Bed electric bariatric
Trendelenberg
See accessory options below

(Note: Other bariatric bed sizes are available on request)

SUPPLIER

Burmark

DIMENSIONS

2000mm inside length
1200mm inside width
200-650mm height adjustment

BRAND

Burmark

MAX USER WEIGHT

300kg

SUPPLIER PRODUCT ID

LH300-1200BT

JDE#

874832

PRICE BREAK

\$5000-\$6000

ORDERING CODE

B262

Accessories

DESCRIPTION	JDE#	SUPPLIER PRODUCT ID	SPECIFICATIONS	PRICE BREAK	ORDERING CODE
Handle support	867114	HR-364-550	364x550mm	\$250-\$500	B260
Handle support	856968	HR-500-550	500x550mm	\$500-\$750	B256
Handle support	876281	HR-800-500	800x550mm	\$500-\$750	B261
Self help pole	851121	Liftpole_dual	Double Handle	\$750-\$1000	B258

Mattress

Band 3



SPECIFICATIONS

Bariatric mattress foam

SUPPLIER

Burmark

DIMENSIONS

2000x1200x180mm

BRAND

Burmark

MAX USER WEIGHT

300kg

SUPPLIER PRODUCT ID

Mat_2000-1200-180B

JDE#

875456

PRICE BREAK

\$1000-\$1500

ORDERING CODE

B263

Whaikaha - Ministry of Disabled People Band 2 & 3 List Equipment

Bedroom

Bed Electric

Band 3



SPECIFICATIONS

Bed electric
See accessory options below
Suitable for Paediatric use

when cotsides are required they must always be ordered as a pair due to safety issues.

The configuration of this bed has high bed-ends designed specifically for the Mesh Cotsides. Standard cotsides will not fit.

SUPPLIER

Cubro

DIMENSIONS

Mattress Platform size 2000x900mm
370-830mm height adjustable

BRAND

Bock Belluno

MAX USER WEIGHT

135kg

SUPPLIER PRODUCT ID	JDE#	PRICE BREAK	ORDERING CODE
920/WA+5105	844334	\$2500-\$3000	B242

Accessories

DESCRIPTION	JDE#	SUPPLIER PRODUCT ID	SPECIFICATIONS	PRICE BREAK	ORDERING CODE
Siderail Drop Down - Left	806418	5120	Mesh High Side	\$1000-\$1500	B243
Siderail Drop Down - Right	806426	5121	Mesh High Side	\$1000-\$1500	B244

Mattress

Band 2



SPECIFICATIONS

Medi Flex Castellated Foam Mattress
Single

SUPPLIER

Cubro

DIMENSIONS

1980x900x150mm

BRAND

MediFlex

MAX USER WEIGHT

N/A

SUPPLIER PRODUCT ID	JDE#	PRICE BREAK	ORDERING CODE
1660	844326	\$500-\$750	B12

Whaikaha - Ministry of Disabled People Band 2 & 3 List Equipment

Bedroom

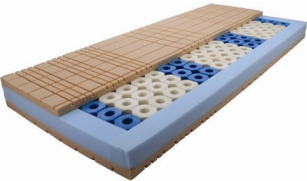
Mattress						Band 3	
			SPECIFICATIONS			Metzeler Prestige Tube	
			SUPPLIER			DIMENSIONS	
Cubro			As per specifications				
BRAND			MAX USER WEIGHT				
Metzeler			250kg				
DESCRIPTION	JDE#	SUPPLIER PRODUCT ID	SPECIFICATIONS	PRICE BREAK	ORDERING CODE		
Single	802901	850	2000x900x180mm	\$3000-\$4000	B280		
Super Single	860027	852	2000x1100x180mm	\$5000-\$6000	B281		
Double	805360	854	2000x1400x180mm	\$5000-\$6000	B282		
Queen	804068	855	2000x1500x180mm	\$6000-\$7000	B283		

Mattress						Band 2	
			SPECIFICATIONS			Roho Mattress Section	
			SUPPLIER			DIMENSIONS	
Permobil							
BRAND			MAX USER WEIGHT				
Roho							
SUPPLIER PRODUCT ID	JDE#		PRICE BREAK	ORDERING CODE			
MA4000	756810		\$1000-\$1500	B284			
Accessories							
DESCRIPTION	JDE#	SUPPLIER PRODUCT ID	PRICE BREAK	ORDERING CODE			
Insert Pad 21x34	755972	MA4003	\$250-\$500	B285			
Cover 4 Section	743867	MCR2PCNSTD-N	\$250-\$500	B286			

Whaikaha - Ministry of Disabled People Band 2 & 3 List Equipment

Bedroom

Mattress Air Alternating		Band 3	
		SPECIFICATIONS	
		Aeria 8 Pro Alternation type: 1 in 3 Alternation cycle: 8-10min	
SUPPLIER		DIMENSIONS	
Cubro		2000x880x220mm	
BRAND		MAX USER WEIGHT	
Aeria		220kg	
SUPPLIER PRODUCT ID	JDE#	PRICE BREAK	ORDERING CODE
2160	777240	\$4500-\$5000	B287

Mattress Air Alternating		Band 3	
		SPECIFICATIONS	
		Aeria 8 Pro Bariatric 110 Wide Alternation type: 1 in 3 Alternation cycle: 8-10min	
SUPPLIER		DIMENSIONS	
Cubro		2000x1100x220mm	
BRAND		MAX USER WEIGHT	
Aeria		250kg	
SUPPLIER PRODUCT ID	JDE#	PRICE BREAK	ORDERING CODE
2165	840923	\$5000-\$5500	B288

Whaikaha - Ministry of Disabled People Band 2 & 3 List Equipment

Kitchen & Living

Chair		Band 2	
		SPECIFICATIONS	
		Rehab chair High back	
SUPPLIER		DIMENSIONS	
Cubro		400 - 550mm adjustable height 490mm width between arms 480 - 520mm adjustable seat depth	
BRAND		MAX USER WEIGHT	
Viking		200kg	
SUPPLIER PRODUCT ID	JDE#	PRICE BREAK	ORDERING CODE
626S	835008	\$250-\$500	K5-H

Lift Out Chair		Band 2	
		SPECIFICATIONS	
		Dual motor Rechargeable battery backup Removable back	
SUPPLIER		DIMENSIONS	
Goldfern Mobility		900mm overall width 440mm width between arms 530mm seat depth	
BRAND		MAX USER WEIGHT	
Goldfern Mobility		150kg	
SUPPLIER PRODUCT ID	JDE#	PRICE BREAK	ORDERING CODE
GM-HYE-8063	854815	\$750-\$1000	K30

Whaikaha - Ministry of Disabled People Band 2 & 3 List Equipment

Manual Handling

Standing Aid		Band 2	
		SPECIFICATIONS	
		Standing Aid Sara Stedy	
SUPPLIER		DIMENSIONS	
Arjo		1050mm overall height 920mm overall length 360 - 750mm inner base width	
BRAND		MAX USER WEIGHT	
Sara Stedy		182kg	
SUPPLIER PRODUCT ID	JDE#	PRICE BREAK	ORDERING CODE
NTB2000	840173	\$2000-\$2500	TB391

Sling		Band 2		
		SPECIFICATIONS		
		Standing Sling For use with Sara Stedy standing aid		
SUPPLIER		DIMENSIONS		
Arjo				
BRAND		MAX USER WEIGHT		
Sara		N/A		
SUPPLIER PRODUCT ID	JDE#	SIZE	PRICE BREAK	ORDERING CODE
TSS.500	777670	Small	\$250-\$500	TB392
TSS.501	777661	Medium	\$250-\$500	TB393
TSS.502	777696	Large	\$250-\$500	TB394
TSS.503	814215	X-large	\$250-\$500	TB395

Whaikaha - Ministry of Disabled People Band 2 & 3 List Equipment

Patient Lifters

Hoist		Band 3	
		SPECIFICATIONS	
		Sit to Stand Lifter	
SUPPLIER		DIMENSIONS	
Active Healthcare		1000mm overall height 980mm overall length 590mm overall width (closed) 450 - 875mm inner base width	
BRAND		MAX USER WEIGHT	
ActivLift 210		210kg	
SUPPLIER PRODUCT ID	JDE#	PRICE BREAK	ORDERING CODE
0252-1004	874648	\$4000-\$4500	TB63

Sling		Band 2		
		SPECIFICATIONS		
		Standfast Fabric Loop For use with Minilift standing hoists		
SUPPLIER		DIMENSIONS		
Active Healthcare				
BRAND		MAX USER WEIGHT		
Smartlift		N/A		
SUPPLIER PRODUCT ID	JDE#	SIZE	PRICE BREAK	ORDERING CODE
0253-1872	808368	Small	\$250-\$500	TB55
0253-1873	801529	Medium	\$250-\$500	TB56
0253-1874	800091	Large	\$250-\$500	TB57
0253-1875	778058	X-large	\$250-\$500	TB58

Whaikaha - Ministry of Disabled People Band 2 & 3 List Equipment

Patient Lifters

Sling		Band 2		
		SPECIFICATIONS		
		Bliss Fabric Loop For use with Minilift standing hoists		
SUPPLIER		DIMENSIONS		
Active Healthcare				
BRAND		MAX USER WEIGHT		
Smartlift		N/A		
SUPPLIER PRODUCT ID	JDE#	SIZE	PRICE BREAK	ORDERING CODE
0253-0899	834540	Small	\$250-\$500	TB51
0253-0898	823630	Medium	\$250-\$500	TB52
0253-0897	808106	Large	\$250-\$500	TB53
0253-0900	828668	X-large	\$250-\$500	TB54

Hoist		Band 2		
		SPECIFICATIONS		
		Birdie Evo Compact Manul Legs - Hoist frame only Please also select Pivot or Spreader bar attachment		
SUPPLIER		DIMENSIONS		
Invacare Ltd		520mm overall width closed (external) 815mm Internal width legs open 1070mm turning radius Lifting range 530mm -1590mm		
BRAND		MAX USER WEIGHT		
Invacare		150kg		
SUPPLIER PRODUCT ID	JDE#	PRICE BREAK	ORDERING CODE	
1650163	901546	\$2500-\$3000	TB385	

Accessories				
DESCRIPTION	JDE#	SUPPLIER PRODUCT ID	PRICE BREAK	ORDERING CODE
Pivot Attachment	901562	1156E	Cost included with hoist	TB386
Spreader bar Attachment	901554	AP1645744-7035	Cost included with hoist	TB387

Whaikaha - Ministry of Disabled People Band 2 & 3 List Equipment

Patient Lifters

Hoist		Band 2		
		SPECIFICATIONS		
		Birdie Evo - Electric Legs Hoist frame only Please also select Pivot or Spreader bar attachment		
SUPPLIER		DIMENSIONS		
Invacare Ltd		640mm overall width closed (external) 1020mm Internal width legs open 1400mm turning radius Lifting range 415mm -1660mm		
BRAND		MAX USER WEIGHT		
Invacare		180kg		
SUPPLIER PRODUCT ID	JDE#	PRICE BREAK	ORDERING CODE	
1650165	901538	\$3000-\$3500	TB388	
Accessories				
DESCRIPTION	JDE#	SUPPLIER PRODUCT ID	PRICE BREAK	ORDERING CODE
Pivot Attachment	901562	1156E	Cost included with hoist	TB386
Spreader bar Attachment	901554	AP1645744-7035	Cost included with hoist	TB387

Yoke Sling		Band 2		
		SPECIFICATIONS		
		Universal High sling Fabric For use with Birdie Evo and Birdie Evo Compact hoists		
SUPPLIER		DIMENSIONS		
Invacare Ltd				
BRAND		MAX USER WEIGHT		
Optisling		N/A		
SUPPLIER PRODUCT ID	JDE#	SIZE	PRICE BREAK	ORDERING CODE
60124058	917767	X-Small	\$250-\$500	TB39
60124059	917775	Small	\$250-\$500	TB40
60124060	917783	Medium	\$250-\$500	TB41
60124061	917791	Large	\$250-\$500	TB42
60124062	917804	X-Large	\$250-\$500	TB43

Whaikaha - Ministry of Disabled People Band 2 & 3 List Equipment

Patient Lifters

Yoke Sling					Band 2
			SPECIFICATIONS		
			Universal High sling Mesh For use with Birdie Evo and Birdie Evo Compact hoists		
SUPPLIER			DIMENSIONS		
Invacare Ltd					
BRAND			MAX USER WEIGHT		
Optisling			N/A		
SUPPLIER PRODUCT ID	JDE#	SIZE	PRICE BREAK	ORDERING CODE	
60124064	917847	Small	\$250-\$500	TB372	
60124065	917855	Medium	\$250-\$500	TB373	
60124066	917863	Large	\$250-\$500	TB374	
60124067	917871	X-Large	\$250-\$500	TB44	

Yoke Sling					Band 2
			SPECIFICATIONS		
			Hygiene High sling Fabric For use with Birdie Evo and Birdie Evo Compact hoists		
SUPPLIER			DIMENSIONS		
Invacare Ltd					
BRAND			MAX USER WEIGHT		
Optisling			N/A		
SUPPLIER PRODUCT ID	JDE#	SIZE	PRICE BREAK	ORDERING CODE	
60123894	917880	X-Small	\$250-\$500	TB389	
60123895	917898	Small	\$250-\$500	TB375	
60123896	917901	Medium	\$250-\$500	TB376	
60123897	917919	Large	\$250-\$500	TB377	
60123898	917927	X-Large	\$250-\$500	TB378	

Whaikaha - Ministry of Disabled People Band 2 & 3 List Equipment

Patient Lifters

Pivot Sling					Band 2
			SPECIFICATIONS		
			Pivot sling General Purpose with Head Support Mesh For use with the Birdie Compact with pivot attachment		
SUPPLIER			DIMENSIONS		
Invacare Ltd					
BRAND			MAX USER WEIGHT		
Novis			N/A		
SUPPLIER PRODUCT ID	JDE#	SIZE	PRICE BREAK	ORDERING CODE	
SL146191	919324	Small	\$250-\$500	TB381	
SL146291	919332	Medium	\$250-\$500	TB382	
SL146391	919341	Large	\$250-\$500	TB383	

Pivot Sling					Band 2
			SPECIFICATIONS		
			Pivot sling Hygiene Mesh For use with the Birdie Compact with pivot attachment		
SUPPLIER			DIMENSIONS		
Invacare Ltd					
BRAND			MAX USER WEIGHT		
Novis			N/A		
SUPPLIER PRODUCT ID	JDE#	SIZE	PRICE BREAK	ORDERING CODE	
SL247191	919359	Small	\$250-\$500	TB340	
SL247291	919367	Medium	\$250-\$500	TB37	
SL247391	919375	Large	\$250-\$500	TB38	

Whaikaha - Ministry of Disabled People Band 2 & 3 List Equipment

Shower & Bath

Bathchair / Bath Support							Band 2
				SPECIFICATIONS			
				Manatee			
SUPPLIER				DIMENSIONS			
Euromedical Ltd				140-430mm adjustable seat height			
BRAND							
R82 of Denmark							
SUPPLIER PRODUCT ID	JDE#	SIZE	WIDTH	MAX USER WEIGHT	PRICE BREAK	ORDERING CODE	
R82-882005	786322	0	420mm	50kg	\$1500-\$1500	P43	
R82-882015	786314	1	420mm	50kg	\$1500-\$1500	P44	
R82-882025	777477	2	420mm	75kg	\$1500-\$1500	P45	
R82-882035	835180	3	490mm	75kg	\$1500-\$1500	P46	

Bathchair / Bath Support							Band 2
				SPECIFICATIONS			
				Flamingo			
SUPPLIER				DIMENSIONS			
Euromedical Ltd							
BRAND							
R82 of Denmark							
SUPPLIER PRODUCT ID	JDE#	SIZE	SEAT WIDTH	OVERALL WIDTH	MAX USER WEIGHT	PRICE BREAK	ORDERING CODE
R82-880001	741351	1	250mm	440mm	33kg	\$3000-\$3500	P85
R82-880002	741360	2	280mm	460mm	50kg	\$3000-\$3500	P86
R82-880003	741378	3	320mm	500mm	60kg	\$3000-\$3500	P87
R82-880004	741386	4	340mm	540mm	70kg	\$3000-\$3500	P88

Whaikaha - Ministry of Disabled People Band 2 & 3 List Equipment

Shower & Bath

Shower Stool		Band 2	
		SPECIFICATIONS	
		Without arms Bariatric Powder coated stainless steel	
SUPPLIER		DIMENSIONS	
Superquip Ltd		465 - 590mm adjustable height	
BRAND		MAX USER WEIGHT	
Superquip		250kg	
SUPPLIER PRODUCT ID	JDE#	PRICE BREAK	ORDERING CODE
056AM	765071	\$250-\$500	BA2

Shower Stool		Band 2	
		SPECIFICATIONS	
		With arms Bariatric Powder coated stainless steel	
SUPPLIER		DIMENSIONS	
Superquip Ltd		600mm width between arms 465 - 590mm adjustable height	
BRAND		MAX USER WEIGHT	
Superquip		250kg	
SUPPLIER PRODUCT ID	JDE#	PRICE BREAK	ORDERING CODE
055AM	764801	\$250-\$500	BA1

Bath Lifter		Band 2		
		SPECIFICATIONS		
		Bath lift Orca		
SUPPLIER		DIMENSIONS		
Invacare Ltd		3750mm seat width without side flaps 7150mm seat width with side flaps 580x285mm base area		
BRAND				
Aquatech				
SUPPLIER PRODUCT ID	JDE#	MAX USER WEIGHT	PRICE BREAK	ORDERING CODE
1573865	834603	135kg	\$500-\$750	S6
1573744	834865	170kg	\$750-\$1000	S7

© All contents within this document are the copyrighted property of Enable New Zealand. Contents may not be copied, reproduced, modified, published, uploaded, posted, transmitted or distributed in any way without the prior written consent of Enable New Zealand.

Whaikaha - Ministry of Disabled People Band 2 & 3 List Equipment

Shower & Bath

Shower Commode		Band 2		
		SPECIFICATIONS		
		Junior Attendant propelled		
SUPPLIER		DIMENSIONS		
Cubro		360mm width between arms		
BRAND		MAX USER WEIGHT		
Juvo Viking		120kg		
SUPPLIER PRODUCT ID	JDE#	PRICE BREAK	ORDERING CODE	
2346J360	875341	\$1500-\$2000	P32	
Accessories				
DESCRIPTION	JDE#	SUPPLIER PRODUCT ID	PRICE BREAK	ORDERING CODE
Closed seat	761791	75HPACB/75PR	\$500-\$750	P169
Open seat	761811	75HPAOB/75PR	\$500-\$750	P170

Shower Commode		Band 2		
		SPECIFICATIONS		
		Junior Self propelled		
SUPPLIER		DIMENSIONS		
Cubro		360mm width between arms		
BRAND		MAX USER WEIGHT		
Juvo Viking		120kg		
SUPPLIER PRODUCT ID	JDE#	PRICE BREAK	ORDERING CODE	
2348J360	875333	\$2500-\$3000	P34	
Accessories				
DESCRIPTION	JDE#	SUPPLIER PRODUCT ID	PRICE BREAK	ORDERING CODE
Closed seat	761791	75HPACB	\$250-\$500	P169
Open seat	761811	75HPAOB	\$250-\$500	P170

Whaikaha - Ministry of Disabled People Band 2 & 3 List Equipment

Shower & Bath

Shower Commode		Band 2		
		SPECIFICATIONS		
		Maxi viking		
SUPPLIER		DIMENSIONS		
Cubro		600mm width between arms		
BRAND		MAX USER WEIGHT		
Juvo Viking		210kg		
SUPPLIER PRODUCT ID	JDE#	PRICE BREAK	ORDERING CODE	
2346M600	875405	\$2000-\$2500	BA41	
Accessories				
DESCRIPTION	JDE#	SUPPLIER PRODUCT ID	PRICE BREAK	ORDERING CODE
Closed seat	761539	75HPCM600/75PR	\$500-\$750	BA43
Open seat	761774	75HPOM600/75PR	\$500-\$750	BA44

Shower Commode Tilt		Band 2		
		SPECIFICATIONS		
		Aquatec Ocean Ergo VIP TNS		
SUPPLIER		DIMENSIONS		
Invacare		480mm width between arms 475-600mm seat height		
BRAND		MAX USER WEIGHT		
Aquatec		150kg		
SUPPLIER PRODUCT ID	JDE#	PRICE BREAK	ORDERING CODE	
PKG-1643577	898025	\$1000-\$1500	S78	

Whaikaha - Ministry of Disabled People Band 2 & 3 List Equipment

Shower & Bath

Shower Commode Tilt

Band 3



SPECIFICATIONS

Viking RAZ TNS

Base unit includes:

Viking RAZ TNS 14

- Adjusta-Back - 430mm (20") H
- Fabric back, 20" high
- Molded Headrest - incl. stainless steel fixing
- Set of clips etc to fit seats on RAZ commodes
- Aqua Soft RAZ Handmade Seat with Junior Aperture
- H-Strap (attached to footrests for calf support)
- Adjustable MFX Footrest 200-300mm

Viking RAZ TNS 16,18 and 20

- Adjusta-Back - 430mm (20") H
- Fabric back, 20" high
- Molded Headrest - incl. stainless steel fixing
- RAZ Molded Seat 450mmW x 400mmD -
- Set of clips etc to fit seats on RAZ commodes
- H-Strap (attached to footrests for calf support)
- Adjustable Footrest 410-520mm

Accessories JDE number 893099

SUPPLIER	ASSESSOR ACCREDITATION
Cubro	
BRAND	MAX USER WEIGHT
Viking	185kg

DESCRIPTION	JDE#	SUPPLIER PRODUCT ID	PRICE BREAK	ORDERING CODE
Viking RAZ TNS 14 Base Unit Open Seat	893013	9900	\$7000-\$8000	S80
Viking RAZ TNS 16 Base Unit Open Seat	893021	9902	\$5000-\$6000	S81
Viking RAZ TNS 18 Base Unit Open Seat	893030	9904	\$5000-\$6000	S82
Viking RAZ TNS 20 Base Unit Open Seat	893048	9906	\$5000-\$6000	S83
Viking RAZ TNS 14 Base Unit Closed Seat	893056	9901	\$7000-\$8000	S84
Viking RAZ TNS 16 Base Unit Closed Seat	893064	9903	\$5000-\$6000	S85
Viking RAZ TNS 18 Base Unit Closed Seat	893072	9905	\$5000-\$6000	S86
Viking RAZ TNS 20 Base Unit Closed Seat	893081	9907	\$5000-\$6000	S87

Whaikaha - Ministry of Disabled People Band 2 & 3 List Equipment

Toileting

Over Toilet Frame		Band 2	
		SPECIFICATIONS	
		Includes splash guard Bariatric Padded armrests Powder coated stainless steel	
SUPPLIER		DIMENSIONS	
Superquip Ltd		600mm width between arms 460 - 585 adjustable height	
BRAND		MAX USER WEIGHT	
Superquip		250kg	
SUPPLIER PRODUCT ID	JDE#	PRICE BREAK	ORDERING CODE
076AM	753328	\$250-\$500	BA3

Whaikaha - Ministry of Disabled People Band 2 & 3 List Equipment

Wheelchairs & Seating

Cushion					Band 2
			DESCRIPTION		
			Jay Ion Cushion		
SUPPLIER			ASSESSOR ACCREDITATION		
Medifab			WMPML1, WMPML1P, WMPML2, WMPML2P		
BRAND			MAX USER WEIGHT		
Jay			136 kg: 14" - 21" wide, 225 kg: 22" - 24" wide		
SUPPLIER PRODUCT ID	JDE#	SIZE (width x depth)	PRICE BREAK	ORDERING CODE	
1705-01-JION1414	875894	14x14	\$250-\$500	CU292	
1705-01-JION1416	852182	14x16	\$250-\$500	CU293	
1705-01-JION1418	884459	14x18	\$250-\$500	CU294	
1705-01-JION1614	866568	16x14	\$250-\$500	CU295	
1705-01-JION1616	861011	16x16	\$250-\$500	CU296	
1705-01-JION1618	842101	16x18	\$250-\$500	CU297	
1705-01-JION1620	844131	16x20	\$250-\$500	CU298	
1705-01-JION1816	911672	18x16	\$250-\$500	CU299	
1705-01-JION1818	837513	18x18	\$250-\$500	CU300	
1705-01-JION1820	874103	18x20	\$250-\$500	CU301	
1705-01-JION2018	846962	20x18	\$250-\$500	CU302	
1705-01-JION2020	842208	20x20	\$250-\$500	CU303	
1705-01-JION2022	872116	20x22	\$250-\$500	CU304	
1705-01-JION2218	898375	22x18	\$500-\$750	CU305	
1705-01-JION2220	894121	22x20	\$750-\$1000	CU306	
1705-01-JION2222	911699	22x22	\$500-\$750	CU307	
1705-01-JION2223	911701	22x23	\$500-\$750	CU308	
1705-01-JION2224	911710	22x24	\$500-\$750	CU309	
1705-01-JION2322	911728	23x22	\$500-\$750	CU310	
1705-01-JION2323	911736	23x23	\$500-\$750	CU311	
1705-01-JION2420	911779	24x20	\$500-\$750	CU312	
1705-01-JION2422	911744	24x22	\$500-\$750	CU313	
1705-01-JION2424	911761	24x24	\$500-\$750	CU314	

Whaikaha - Ministry of Disabled People Band 2 & 3 List Equipment

Wheelchairs & Seating

Cushion				Band 2
		DESCRIPTION		
		Vigour Standard Contour Cushion		
SUPPLIER		ASSESSOR ACCREDITATION		
Medifab		WMPML1, WMPML1P, WMPML2, WMPML2P		
BRAND		MAX USER WEIGHT		
Vigour		10" - 15" 90Kg, 16"- 20" 160Kg		
SUPPLIER PRODUCT ID	JDE#	SIZE (width x depth)	PRICE BREAK	ORDERING CODE
1103-0808-OSC	911859	8x8	\$500-\$750	CU315
1103-0810-OSC	911867	8x10	\$500-\$750	CU316
1103-1010-OSC	889381	10x10	\$500-\$750	CU317
1103-1012-OSC	840392	10x12	\$500-\$750	CU318
1103-1212-OSC	752501	12x12	\$500-\$750	CU245
1103-1214-OSC	752510	12x14	\$500-\$750	CU246
1103-1414-OSC	752528	14x14	\$500-\$750	CU247
1103-1416-OSC	752536	14x16	\$500-\$750	CU248
1103-1418-OSC	909062	14x18	\$500-\$750	CU319
1103-1616-OSC	752544	16x16	\$500-\$750	CU249
1103-1618-OSC	752552	16x18	\$500-\$750	CU250
1103-1620-OSC	874197	16x20	\$500-\$750	CU320
1103-1816-OSC	902522	18x16	\$500-\$750	CU321
1103-1818-OSC	752579	18x18	\$500-\$750	CU251
1103-1820-OSC	848407	18x20	\$500-\$750	CU252
1103-2020-OSC	752595	20x20	\$500-\$750	CU253
1103-2022-OSC	853716	20x22	\$500-\$750	CU322
1103-2218-OSC	911883	22x18	\$750-\$1000	CU323
1103-2220-OSC	900148	22x20	\$750-\$1000	CU324
1103-2222-OSC	911891	22x22	\$750-\$1000	CU325
1103-2418-OSC	897241	24x18	\$750-\$1000	CU326
1103-2420-OSC	911912	24x20	\$750-\$1000	CU327
1103-2422-OSC	911939	24x22	\$750-\$1000	CU328

Whaikaha - Ministry of Disabled People Band 2 & 3 List Equipment

Wheelchairs & Seating

Cushion				Band 2
		DESCRIPTION		
		Jay Union Cushion		
SUPPLIER		ASSESSOR ACCREDITATION		
Medifab		WMPML1, WMPML1P, WMPML2, WMPML2P		
BRAND		MAX USER WEIGHT		
Jay		136 kg: 14" - 21" wide, 225 kg: 22" - 24" wide		
SUPPLIER PRODUCT ID	JDE#	SIZE (width x depth)	PRICE BREAK	ORDERING CODE
1707-01-JU1414	911971	14x14	\$500-\$750	CU329
1707-01-JU1416	875561	14x16	\$500-\$750	CU330
1707-01-JU1418	867026	14x18	\$500-\$750	CU331
1707-01-JU1614	911998	16x14	\$500-\$750	CU332
1707-01-JU1616	867317	16x16	\$500-\$750	CU333
1707-01-JU1618	854436	16x18	\$500-\$750	CU334
1707-01-JU1620	889495	16x20	\$500-\$750	CU335
1707-01-JU1816	912018	18x16	\$500-\$750	CU336
1707-01-JU1818	868838	18x18	\$500-\$750	CU337
1707-01-JU1820	849661	18x20	\$500-\$750	CU338
1707-01-JU2018	869187	20x18	\$500-\$750	CU339
1707-01-JU2020	869646	20x20	\$500-\$750	CU340
1707-01-JU2022	892601	20x22	\$500-\$750	CU341
1707-01-JU2218	867739	22x18	\$750-\$1000	CU342
1707-01-JU2220	911411	22x20	\$750-\$1000	CU343
1707-01-JU2222	912026	22x22	\$750-\$1000	CU344
1707-01-JU2223	912034	22x23	\$750-\$1000	CU345
1707-01-JU2224	912042	22x24	\$750-\$1000	CU346
1707-01-JU2322	912051	23x22	\$750-\$1000	CU347
1707-01-JU2323	912069	23x23	\$750-\$1000	CU348
1707-01-JU2420	912077	24x20	\$750-\$1000	CU349
1707-01-JU2422	912085	24x22	\$750-\$1000	CU350
1707-01-JU2424	912093	24x24	\$750-\$1000	CU351

Whaikaha - Ministry of Disabled People Band 2 & 3 List Equipment

Wheelchairs & Seating

Cushion Modular				Band 3
		DESCRIPTION		
		Dreamline Contour Cushion		
SUPPLIER		ASSESSOR ACCREDITATION		
Permobil		WMPML1, WMPML1P, WMPML2, WMPML2P		
BRAND		MAX USER WEIGHT		
Dreamline		120 Kg		
SUPPLIER PRODUCT ID	JDE#	SIZE (width x depth)	PRICE BREAK	ORDERING CODE
DCC0808	911437	8x8	\$750-\$1000	CU416
DCC0810	911445	8x10	\$500-\$750	CU417
DCC1010	911453	10x10	\$500-\$750	CU418
DCC1012	872095	10x12	\$500-\$750	CU419
DCC1212	904931	12x12	\$500-\$750	CU420
DCC1214	855973	12x14	\$500-\$750	CU421
DCC1414	855666	14x14	\$500-\$750	CU422
DCC1416	852529	14x16	\$500-\$750	CU423
DCC1418	911461	14x18	\$500-\$750	CU424
DCC1616	849901	16x16	\$500-\$750	CU425
DCC1618	847383	16x18	\$750-\$1000	CU426
DCC1620	848010	16x20	\$750-\$1000	CU427
DCC1816	861927	18x16	\$750-\$1000	CU428
DCC1818	846751	18x18	\$750-\$1000	CU429
DCC1820	849098	18x20	\$750-\$1000	CU430
DCC2018	847711	20x18	\$750-\$1000	CU431
DCC2020	851340	20x20	\$750-\$1000	CU432
DCC2218	895351	22x18	\$750-\$1000	CU433
DCC2220	883595	22x20	\$750-\$1000	CU434
DCC2222	892740	22x22	\$750-\$1000	CU435
DCC2420	883894	24x20	\$750-\$1000	CU436
DCC2422	911470	24x22	\$750-\$1000	CU437
DCC2424	911488	24x24	\$750-\$1000	CU438

Whaikaha - Ministry of Disabled People Band 2 & 3 List Equipment

Wheelchairs & Seating

Cushion Modular

Band 3

	DESCRIPTION
	Dreamline Support Cushion

SUPPLIER	ASSESSOR ACCREDITATION
Permobil	WMPML1, WMPML1P, WMPML2, WMPML2P

BRAND	MAX USER WEIGHT
Dreamline	120 Kg

SUPPLIER PRODUCT ID	JDE#	SIZE (width x depth)	PRICE BREAK	ORDERING CODE
DSC0808	911496	8x8	\$750-\$1000	CU369
DSC0810	911509	8x10	\$750-\$1000	CU370
DSC1010	876213	10x10	\$750-\$1000	CU371
DSC1012	911517	10x12	\$750-\$1000	CU372
DSC1212	861901	12x12	\$750-\$1000	CU373
DSC1214	871404	12x14	\$750-\$1000	CU374
DSC1414	884344	14x14	\$750-\$1000	CU375
DSC1416	856351	14x16	\$750-\$1000	CU376
DSC1418	863033	14x18	\$750-\$1000	CU377
DSC1616	854031	16x16	\$750-\$1000	CU378
DSC1618	855623	16x18	\$750-\$1000	CU379
DSC1620	854102	16x20	\$750-\$1000	CU380
DSC1816	851391	18x16	\$750-\$1000	CU381
DSC1818	851382	18x18	\$750-\$1000	CU382
DSC1820	852764	18x20	\$750-\$1000	CU383
DSC2018	867253	20x18	\$750-\$1000	CU384
DSC2020	858816	20x20	\$750-\$1000	CU385
DSC2218	895668	22x18	\$750-\$1000	CU386
DSC2220	863295	22x20	\$750-\$1000	CU387
DSC2222	911525	22x22	\$750-\$1000	CU388
DSC2420	911533	24x20	\$750-\$1000	CU389
DSC2422	911541	24x22	\$750-\$1000	CU390
DSC2424	911550	24x24	\$750-\$1000	CU391

Whaikaha - Ministry of Disabled People Band 2 & 3 List Equipment

Wheelchairs & Seating

Cushion Modular				Band 3
			DESCRIPTION	
			Spex High Contour Cushion	
SUPPLIER			ASSESSOR ACCREDITATION	
Medifab			WMPML1, WMPML1P, WMPML2, WMPML2P	
BRAND			MAX USER WEIGHT	
Spex High Contour			10"- 15" 90 Kg, 16"-20" 160 Kg	
SUPPLIER PRODUCT ID	JDE#	SIZE (width x depth)	PRICE BREAK	ORDERING CODE
1105-0808-0HC	912261	8x8	\$750-\$1000	CU392
1105-0810-0HC	912296	8x10	\$750-\$1000	CU393
1105-1010-0HC	849442	10x10	\$500-\$750	CU394
1105-1012-0HC	845185	10x12	\$500-\$750	CU395
1105-1212-0HC	840211	12x12	\$500-\$750	CU396
1105-1214-0HC	849055	12x14	\$500-\$750	CU397
1105-1414-0HC	841969	14x14	\$500-\$750	CU398
1105-1416-0HC	841459	14x16	\$500-\$750	CU399
1105-1616-0HC	841467	16x16	\$500-\$750	CU400
1105-1618-0HC	842312	16x18	\$500-\$750	CU401
1105-1620-0HC	847236	16x20	\$750-\$1000	CU402
1105-1816-0HC	857186	18x16	\$500-\$750	CU403
1105-1818-0HC	841707	18x18	\$750-\$1000	CU404
1105-1820-0HC	840077	18x20	\$750-\$1000	CU405
1105-2018-0HC	860916	20x18	\$750-\$1000	CU406
1105-2020-0HC	853871	20x20	\$750-\$1000	CU407
1105-2022-0HC	866701	20x22	\$750-\$1000	CU408
1105-2218-0HC	912309	22x18	\$1000-\$1500	CU409
1105-2220-0HC	912333	22x20	\$750-\$1000	CU410
1105-2222-0HC	889225	22x22	\$750-\$1000	CU411
1105-2418-0HC	912341	24x18	\$750-\$1000	CU412
1105-2420-0HC	912350	24x20	\$750-\$1000	CU413
1105-2422-0HC	912368	24x22	\$750-\$1000	CU414
1105-2424-0HC	912405	24x24	\$750-\$1000	CU415

Whaikaha - Ministry of Disabled People Band 2 & 3 List Equipment

Wheelchairs & Seating

Cushion Modular				Band 3
		DESCRIPTION		
		Spex Standard Contour Cushion		
SUPPLIER		ASSESSOR ACCREDITATION		
Medifab		WMPML1, WMPML1P, WMPML2, WMPML2P		
BRAND		MAX USER WEIGHT		
Spex		10"- 15" 90 kg, 16"-20" 160 kg		
SUPPLIER PRODUCT ID	JDE#	SIZE (width x depth)	PRICE BREAK	ORDERING CODE
1105-0808-OSC	912106	8x8	\$500-\$750	CU352
1105-0810-OSC	912114	8x10	\$500-\$750	CU353
1105-1010-OSC	912122	10x10	\$500-\$750	CU354
1105-1012-OSC	883536	10x12	\$500-\$750	CU355
1105-1212-OSC	746195	12x12	\$500-\$750	CU255
1105-1214-OSC	746208	12x14	\$500-\$750	CU256
1105-1414-OSC	746216	14x14	\$500-\$750	CU257
1105-1416-OSC	746224	14x16	\$500-\$750	CU258
1105-1418-OSC	855210	14x18	\$500-\$750	CU356
1105-1616-OSC	746232	16x16	\$500-\$750	CU259
1105-1618-OSC	746241	16x18	\$500-\$750	CU260
1105-1620-OSC	912131	16x20	\$500-\$750	CU357
1105-1816-OSC	912149	18x16	\$750-\$1000	CU358
1105-1818-OSC	746267	18x18	\$750-\$1000	CU262
1105-1820-OSC	746275	18x20	\$750-\$1000	CU263
1105-2018-OSC	869566	20x18	\$750-\$1000	CU359
1105-2020-OSC	912157	20x20	\$750-\$1000	CU360
1105-2022-OSC	853724	20x22	\$750-\$1000	CU361
1105-2218-OSC	912165	22x18	\$1000-\$1500	CU362
1105-2220-OSC	864642	22x20	\$750-\$1000	CU363
1105-2222-OSC	912173	22x22	\$750-\$1000	CU364
1105-2418-OSC	893460	24x18	\$750-\$1000	CU365
1105-2420-OSC	912181	24x20	\$750-\$1000	CU366
1105-2422-OSC	912190	24x22	\$750-\$1000	CU367
1105-2424-OSC	912202	24x24	\$750-\$1000	CU368

Whaikaha - Ministry of Disabled People Band 2 & 3 List Equipment

Wheelchairs & Seating

Cushion Modular				Band 3
		DESCRIPTION		
		Spex Super High Contour Cushion		
SUPPLIER		ASSESSOR ACCREDITATION		
Medifab		WMPML1, WMPML1P, WMPML2, WMPML2P		
BRAND		MAX USER WEIGHT		
Spex		10"- 15" 90 Kg, 16"- 20" 160 Kg		
SUPPLIER PRODUCT ID	JDE#	SIZE (width x depth)	PRICE BREAK	ORDERING CODE
1105-0808-OSS	912421	8x8	\$750-\$1000	CU439
1105-0810-OSS	912456	8x10	\$750-\$1000	CU440
1105-1010-OSS	912481	10x10	\$750-\$1000	CU441
1105-1012-OSS	912587	10x12	\$750-\$1000	CU442
1105-1212-OSS	898041	12x12	\$750-\$1000	CU443
1105-1214-OSS	912616	12x14	\$750-\$1000	CU444
1105-1414-OSS	912624	14x14	\$750-\$1000	CU445
1105-1416-OSS	868977	14x16	\$750-\$1000	CU446
1105-1418-OSS	912641	14x18	\$1000-\$1500	CU447
1105-1616-OSS	912659	16x16	\$750-\$1000	CU448
1105-1618-OSS	896290	16x18	\$750-\$1000	CU449
1105-1620-OSS	912675	16x20	\$750-\$1000	CU450
1105-1816-OSS	912691	18x16	\$1000-\$1500	CU451
1105-1818-OSS	912721	18x18	\$750-\$1000	CU452
1105-1820-OSS	897760	18x20	\$750-\$1000	CU453
1105-2018-OSS	912704	20x18	\$1000-\$1500	CU454
1105-2022-OSS	912712	20x22	\$750-\$1000	CU456

Whaikaha - Ministry of Disabled People Band 2 & 3 List Equipment

Wheelchairs & Seating

Cushion Hybrid				Band 3
		DESCRIPTION		
		Jay Fusion Air Cushion		
SUPPLIER		ASSESSOR ACCREDITATION		
Medifab		WMPML1, WMPML1P, WMPML2, WMPML2P		
BRAND		MAX USER WEIGHT		
Jay		14- 21": 136 kg, 22 - 24": 225 kg		
SUPPLIER PRODUCT ID	JDE#	SIZE (width x depth)	PRICE BREAK	ORDERING CODE
1713-07-JFUSION1414AD	912325	14x14	\$750-\$1000	CU509
1713-07-JFUSION1416AD	912317	14x16	\$750-\$1000	CU510
1713-07-JFUSION1416AD	877275	14x18	\$750-\$1000	CU511
1713-07-JFUSION1418AD	912288	16x14	\$750-\$1000	CU512
1713-07-JFUSION1616AD	912270	16x16	\$750-\$1000	CU513
1713-07-JFUSION1618AD	866980	16x18	\$750-\$1000	CU514
1713-07-JFUSION1620AD	912253	16x20	\$750-\$1000	CU515
1713-07-JFUSION1816AD	912245	18x16	\$750-\$1000	CU516
1713-07-JFUSION1818AD	861388	18x18	\$750-\$1000	CU517
1713-07-JFUSION1820AD	912237	18x20	\$750-\$1000	CU518
1713-07-JFUSION2018AD	912229	20x18	\$750-\$1000	CU519
1713-07-JFUSION2020AD	865611	20x20	\$750-\$1000	CU520
1713-07-JFUSION2022AD	912211	20x22	\$750-\$1000	CU521
1713-07-JFUSION2218AD	912000	22x18	\$1000-\$1500	CU522
1713-07-JFUSION2222AD	911980	22x22	\$750-\$1000	CU523
1713-07-JFUSION2223AD	911963	22x23	\$750-\$1000	CU524
1713-07-JFUSION2224AD	911955	22x24	\$750-\$1000	CU525
1713-07-JFUSION2420AD	911947	24x20	\$750-\$1000	CU526
1713-07-JFUSION2421AD	911921	24x21	\$750-\$1000	CU527
1713-07-JFUSION2422AD	911904	24x22	\$750-\$1000	CU528
1713-07-JFUSION2424AD	911875	24x24	\$750-\$1000	CU529

Whaikaha - Ministry of Disabled People Band 2 & 3 List Equipment

Wheelchairs & Seating

Cushion Hybrid				Band 3
		DESCRIPTION		
		Jay Fusion Fluid Cushion		
SUPPLIER		ASSESSOR ACCREDITATION		
Medifab		WMPML1, WMPML1P, WMPML2, WMPML2P		
BRAND		MAX USER WEIGHT		
Jay		14- 21": 136 kg, 22 - 24": 225 kg		
SUPPLIER PRODUCT ID	JDE#	SIZE (width x depth)	PRICE BREAK	ORDERING CODE
1713-01-JFUSION1414	912501	14x14	\$750-\$1000	CU488
1713-01-JFUSION1416	887617	14x16	\$750-\$1000	CU489
1713-01-JFUSION1418	888409	14x18	\$750-\$1000	CU490
1713-01-JFUSION1614	912499	16x14	\$750-\$1000	CU491
1713-01-JFUSION1616	848191	16x16	\$750-\$1000	CU492
1713-01-JFUSION1618	843673	16x18	\$750-\$1000	CU493
1713-01-JFUSION1620	899722	16x20	\$750-\$1000	CU494
1713-01-JFUSION1816	912472	18x16	\$750-\$1000	CU495
1713-01-JFUSION1818	908166	18x18	\$750-\$1000	CU496
1713-01-JFUSION1820	892977	18x20	\$750-\$1000	CU497
1713-01-JFUSION2018	875704	20x18	\$750-\$1000	CU498
1713-01-JFUSION2020	897786	20x20	\$750-\$1000	CU499
1713-01-JFUSION2022	862604	20x22	\$750-\$1000	CU500
1713-01-JFUSION2218	912464	22x18	\$1000-\$1500	CU501
1713-01-JFUSION2222	912448	22x22	\$750-\$1000	CU502
1713-01-JFUSION2223	911402	22x23	\$750-\$1000	CU503
1713-01-JFUSION2224	912430	22x24	\$750-\$1000	CU504
1713-01-JFUSION2420	912413	24x20	\$750-\$1000	CU505
1713-01-JFUSION2421	912392	24x21	\$750-\$1000	CU506
1713-01-JFUSION2422	912384	24x22	\$750-\$1000	CU507
1713-01-JFUSION2424	912376	24x24	\$750-\$1000	CU508

Whaikaha - Ministry of Disabled People Band 2 & 3 List Equipment

Wheelchairs & Seating

Cushion Hybrid				Band 3
		DESCRIPTION		
		Roho Hybrid Elite Dual Valve Cushion		
SUPPLIER		ASSESSOR ACCREDITATION		
Permobil		WMPML1, WMPML1P, WMPML2, WMPML2P		
BRAND		MAX USER WEIGHT		
Roho		225 kg		
SUPPLIER PRODUCT ID	JDE#	SIZE (width x depth)	PRICE BREAK	ORDERING CODE
CU4172.1	847121	14x16	\$1000-\$1500	CU541
CU4177.1	846209	16x16	\$750-\$1000	CU542
CU4179.1	843745	16x18	\$750-\$1000	CU543
CU4180.1	911681	16x20	\$750-\$1000	CU544
CU4184.1	851884	18x16	\$750-\$1000	CU545
CU4186.1	899482	18x18	\$750-\$1000	CU546
CU4187.1	911752	18x20	\$750-\$1000	CU547
CU4189.1	850208	20x18	\$750-\$1000	CU548
CU4190.1	911787	20x20	\$750-\$1000	CU549
CU4191.1	911795	22x18	\$750-\$1000	CU550
CU4192.1	911808	22x20	\$750-\$1000	CU551
CU4193.1	911816	22x22	\$750-\$1000	CU552
CU4194.1	911824	24x18	\$750-\$1000	CU553
CU4195.1	911832	24x20	\$750-\$1000	CU554

Whaikaha - Ministry of Disabled People Band 2 & 3 List Equipment

Wheelchairs & Seating

Cushion Hybrid				Band 3
		DESCRIPTION		
		Vicair Active 02 9 Cushion		
SUPPLIER		ASSESSOR ACCREDITATION		
Morton & Perry		WMPML1, WMPML1P, WMPML2, WMPML2P		
BRAND		MAX USER WEIGHT		
Vicair		200 Kg		
SUPPLIER PRODUCT ID	JDE#	SIZE (width x depth)	PRICE BREAK	ORDERING CODE
XVOCT9/3540	895991	35x40	\$750-\$1000	CU530
XVOCT9/4040	911841	40x40	\$750-\$1000	CU531
XVOCT9/4045	880423	40x45	\$750-\$1000	CU532
XVOCT9/4050	889356	40x50	\$750-\$1000	CU533
XVOCT9/4540	912835	45x40	\$750-\$1000	CU534
XVOCT9/4545	892491	45x45	\$750-\$1000	CU535
XVOCT9/4550	884627	45x50	\$750-\$1000	CU536
XVOCT9/5045	893822	50x45	\$750-\$1000	CU537
XVOCT9/5050	899175	50x50	\$750-\$1000	CU538
XVOCT9/5550	908625	55x50	\$750-\$1000	CU539
XVOCT9/6050	896193	60x50	\$750-\$1000	CU540

Whaikaha - Ministry of Disabled People Band 2 & 3 List Equipment

Wheelchairs & Seating

Cushion High Pressure Relief				Band 3
		DESCRIPTION		
		Vicair Adjuster O2 10 Cushion		
SUPPLIER		ASSESSOR ACCREDITATION		
Morton & Perry		WMPML1, WMPML1P, WMPML2, WMPML2P		
BRAND		MAX USER WEIGHT		
Vicair		250 Kg		
SUPPLIER PRODUCT ID	JDE#	SIZE (width x depth)	PRICE BREAK	ORDERING CODE
XVOAD10/3540	912683	35x40	\$750-\$1000	CU458
XVOAD10/4040	912667	40x40	\$750-\$1000	CU459
XVOAD10/4045	880790	40x45	\$750-\$1000	CU460
XVOAD10/4050	879975	40x50	\$750-\$1000	CU461
XVOAD10/4540	912632	45x40	\$750-\$1000	CU462
XVOAD10/4545	883384	45x45	\$750-\$1000	CU463
XVOAD10/4550	883510	45x50	\$750-\$1000	CU464
XVOAD10/5045	888530	50x45	\$750-\$1000	CU465
XVOAD10/5050	891886	50x50	\$750-\$1000	CU466
XVOAD10/5550	908924	55x50	\$750-\$1000	CU467
XVOAD10/6050	912608	60x50	\$750-\$1000	CU468

Whaikaha - Ministry of Disabled People Band 2 & 3 List Equipment

Wheelchairs & Seating

Cushion High Pressure Relief

Band 3

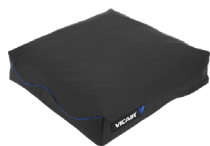

DESCRIPTION

Vicair Vector O2 10 Cushion

SUPPLIER

Morton & Perry

ASSESSOR ACCREDITATION

WMPML1, WMPML1P, WMPML2, WMPML2P

BRAND

Vicair

MAX USER WEIGHT

250 Kg

SUPPLIER PRODUCT ID	JDE#	SIZE (width x depth)	PRICE BREAK	ORDERING CODE
XVOVR10/3540	889372	35x40	\$750-\$1000	CU469
XVOVR10/4040	876037	40x40	\$750-\$1000	CU470
XVOVR10/4045	888572	40x45	\$750-\$1000	CU471
XVOVR10/4050	889639	40x50	\$1000-\$1500	CU472
XVOVR10/4540	912595	45x40	\$750-\$1000	CU473
XVOVR10/4545	912579	45x45	\$750-\$1000	CU474
XVOVR10/4550	912561	45x50	\$750-\$1000	CU475
XVOVR10/5045	912552	50x45	\$750-\$1000	CU476
XVOVR10/5050	912544	50x50	\$750-\$1000	CU477
XVOVR10/5550	912536	55x50	\$750-\$1000	CU478
XVOVR10/6050	912528	60x50	\$750-\$1000	CU479

Whaikaha - Ministry of Disabled People Band 2 & 3 List Equipment

Wheelchairs & Seating

Cushion High Pressure Relief Band 3



	DESCRIPTION
--	-------------

	Roho Quattro Select High Profile Cushion
--	--

SUPPLIER	ASSESSOR ACCREDITATION
----------	------------------------

Permobil	WMPML1, WMPML1P, WMPML2, WMPML2P
----------	----------------------------------

BRAND	MAX USER WEIGHT
-------	-----------------

Roho	No Weight Limit
------	-----------------

SUPPLIER PRODUCT ID	JDE#	SIZE (width x depth)	PRICE BREAK	ORDERING CODE
CU4057	750143	12x12	\$1000-\$1500	CU278
CU4087	750303	14x14	\$1000-\$1500	CU279
CU4090	750320	14x16	\$1000-\$1500	CU280
CU4076	750240	14x18	\$1000-\$1500	CU480
CU4079	750274	14x20	\$1000-\$1500	CU481
CU4110	750426	16x14	\$1000-\$1500	CU482
CU4113	750442	16x16	\$1000-\$1500	CU281
CU4093	750346	16x18	\$1000-\$1500	CU282
CU4096	750362	16x20	\$1000-\$1500	CU283
CU4000	774840	18x18	\$1000-\$1500	CU284
CU4003	812510	18x20	\$1000-\$1500	CU483
CU4017	749994	20x18	\$1000-\$1500	CU286
CU4020	750012	20x20	\$1000-\$1500	CU287
CU4023	750039	20x22	\$1000-\$1500	CU484
CU4032	750071	22x18	\$1000-\$1500	CU485
CU4043	750119	24x18	\$1000-\$1500	CU486
CU4046	750127	24x20	\$1000-\$1500	CU487

Whaikaha - Ministry of Disabled People Band 2 & 3 List Equipment

Wheelchairs & Seating

Planer Back Support				Band 2
		SPECIFICATIONS		
		Vigour Hi Back with Cover Supportive foam unit, outer anti-shear breathable cover, aluminium shell, positioning wedges.		
SUPPLIER		STANDARD HARDWARE		
Medifab		Quad Mount		
BRAND		MAX USER WEIGHT		
Vigour		Up to 15 wide 90kg 16+ wide 160kg		
SUPPLIER PRODUCT ID	JDE#	SIZE	PRICE BREAK	ORDERING CODE
1252-1012-00H	892361	10x12	\$1000-\$1500	BR20
1252-1016-00H	862031	10x16	\$1000-\$1500	BR22
1252-1214-00H	738259	12x14	\$1000-\$1500	BR23
1252-1216-00H	869355	12x16	\$1000-\$1500	BR24
1252-1218-00H	805263	12x18	\$1000-\$1500	BR25
1252-1416-00H	871498	14x16	\$1000-\$1500	BR26
1252-1418-00H	738267	14x18	\$1000-\$1500	BR27
1252-1420-00H	805271	14x20	\$1000-\$1500	BR28
1252-1618-00H	872378	16x18	\$1000-\$1500	BR29
1252-1620-00H	738275	16x20	\$1000-\$1500	BR30
1252-1623-00H	805280	16x23	\$1000-\$1500	BR31
1252-1818-00H	880239	18x18	\$1000-\$1500	BR32
1252-1820-00H	738291	18x20	\$1000-\$1500	BR33
1252-1823-00H	805301	18x23	\$1000-\$1500	BR34
1252-2018-00H	871703	20x18	\$1000-\$1500	BR35
1252-2020-00H	867608	20x20	\$1000-\$1500	BR36
1252-2023-00H	869339	20x23	\$1000-\$1500	BR37
1258-2216-00H	924043	22x16	\$1000-\$1500	BR165
1258-2220-00H	924051	22x20	\$1000-\$1500	BR166
1258-2416-00H	924060	24x16	\$1000-\$1500	BR167
1258-2420-00H	924078	24x20	\$1000-\$1500	BR168
1258-2616-00H	924086	26x16	\$1000-\$1500	BR169
1258-2620-00H	924094	26x20	\$1000-\$1500	BR170

Whaikaha - Ministry of Disabled People Band 2 & 3 List Equipment

Wheelchairs & Seating

Planer Back Support					Band 2
			SPECIFICATIONS		
			Nxt Xtend - Height Adjustable (Active) Back Width adjustable mounting hardware with one-hand quick release bar		
SUPPLIER			STANDARD HARDWARE		
Morton & Perry			Quickfit Cane and back brackets		
BRAND			MAX USER WEIGHT		
Nxt Xtend					
SUPPLIER PRODUCT ID	JDE#	SIZE	PRICE BREAK	ORDERING CODE	
XDNHAACB1616/20	877494	16x16-20	\$1000-\$1500	BR38	
XDNHAACB1816/20	892205	18x16-20	\$1000-\$1500	BR39	
XDNHAACB2016/20	880503	20x16-20	\$1000-\$1500	BR40	

Whaikaha - Ministry of Disabled People Band 2 & 3 List Equipment

Wheelchairs & Seating

Planer Back Support				Band 2
		SPECIFICATIONS Dreamline Support Quick Release Complete Shell with Dreamline Support Foam and Outer Cover		
SUPPLIER		STANDARD HARDWARE		
Permobil		U2 Quick Release Brackets		
BRAND		MAX USER WEIGHT		
Dreamline Support				
SUPPLIER PRODUCT ID	JDE#	SIZE	PRICE BREAK	ORDERING CODE
DSB0810	922873	8x10	\$1000-\$1500	BR41
DSB0812	922881	8x12	\$1000-\$1500	BR42
DSB1012	922890	10x12	\$1000-\$1500	BR43
DSB1014	922902	10x14	\$1000-\$1500	BR44
DSB1214	922911	12x14	\$1000-\$1500	BR45
DSB1216	922929	12x16	\$1000-\$1500	BR46
DSB1218	922937	12x18	\$1000-\$1500	BR47
DSB1416	922945	14x16	\$1000-\$1500	BR48
DSB1418	922953	14x18	\$1000-\$1500	BR49
DSB1420	922961	14x20	\$1000-\$1500	BR50
DSB1618	922970	16x18	\$1000-\$1500	BR51
DSB1620	922988	16x20	\$1000-\$1500	BR52
DSB1622	922996	16x22	\$1000-\$1500	BR53
DSB1818	923008	18x18	\$1000-\$1500	BR54
DSB1820	923016	18x20	\$1000-\$1500	BR55
DSB1822	923024	18x22	\$1000-\$1500	BR56
DSB2018	923032	20x18	\$1000-\$1500	BR57
DSB2020	923041	20x20	\$1000-\$1500	BR58
DSB2022	923059	20x22	\$1000-\$1500	BR59

Whaikaha - Ministry of Disabled People Band 2 & 3 List Equipment

Wheelchairs & Seating

Active Contour Back Support				Band 2
		SPECIFICATIONS		
		Varilite Icon Mid Back with Cover Air-foam cushion, aluminium shell, Varilock metal mounting hardware that allows for 20° back angle adjustment.		
SUPPLIER		STANDARD HARDWARE		
Allied Medical		Varilock steel hardware (single point per side)		
BRAND		MAX USER WEIGHT		
Varilite		136 Kgs		
SUPPLIER PRODUCT ID	JDE#	SIZE	PRICE BREAK	ORDERING CODE
VL440012121	812480	12x9.7	\$750-\$1000	BR1
VL440012141	812498	14x11.2	\$750-\$1000	BR2
VL440012161	812501	16x12.7	\$750-\$1000	BR3
VL440012171	812519	17x13.5	\$750-\$1000	BR4
VL440012181	812527	18x14.24	\$750-\$1000	BR5
VL440012201	812535	20x15.75	\$750-\$1000	BR6

Active Contour Back Support				Band 2
		SPECIFICATIONS		
		Nxt Optima Carbon Active Contour Width adjustable mounting hardware with one-hand quick release bar		
SUPPLIER		STANDARD HARDWARE		
Morton & Perry		Quickfit Cane and back brackets		
BRAND		MAX USER WEIGHT		
Nxt Optima				
SUPPLIER PRODUCT ID	JDE#	SIZE	PRICE BREAK	ORDERING CODE
XDNOCFACB14/09	887115	14x9	\$1000-\$1500	BR60
XDNOCFACB14/13	897372	14x13	\$1000-\$1500	BR61
XDNOCFACB16/09	923139	16x9	\$750-\$1000	BR62
XDNOCFACB16/13	848853	16x13	\$750-\$1000	BR63
XDNOCFACB17/09	923147	17x9	\$750-\$1000	BR64
XDNOCFACB17/13	923155	17x13	\$750-\$1000	BR65
XDNOCFACB18/13	923163	18x13	\$750-\$1000	BR66
XDNOCFACB18/16	846831	18x16	\$1000-\$1500	BR67

Whaikaha - Ministry of Disabled People Band 2 & 3 List Equipment

Wheelchairs & Seating

Active Contour Back Support				Band 2
		SPECIFICATIONS Zygo Active Contour Back Support Supportive foam unit, outer anti-shear breathable cover, contoured aluminium shell, positioning wedges, modesty flap.		
		SUPPLIER Medifab		
BRAND Zygo		STANDARD HARDWARE Drop Mount hardware		
MAX USER WEIGHT 136kg				
SUPPLIER PRODUCT ID	JDE#	SIZE	PRICE BREAK	ORDERING CODE
1251-1009-0AM	923180	10x9	\$1000-\$1500	BR68
1251-1207-0AL	923198	12x7	\$750-\$1000	BR69
1251-1210-0AM	923219	12x10	\$1000-\$1500	BR70
1251-1212-0AM	923227	12x12	\$1000-\$1500	BR71
1251-1408-0AL	923235	14x8	\$750-\$1000	BR72
1251-1413-0AM	923243	14x13	\$1000-\$1500	BR73
1251-1415-0AM	923163	14x15	\$1000-\$1500	BR74
1251-1609-0AL	923260	16x9	\$750-\$1000	BR75
1251-1614-0AM	923278	16x14	\$1000-\$1500	BR76
1251-1616-0AM	923286	16x16	\$1000-\$1500	BR77
1251-1809-0AL	923294	18x9	\$750-\$1000	BR78
1251-1815-0AM	923307	18x15	\$1000-\$1500	BR79
1251-1817-0AM	923315	18x17	\$1000-\$1500	BR80
1251-2011-0AL	923323	20x11	\$750-\$1000	BR81
1251-2015-0AM	923331	20x15	\$750-\$1000	BR82
1251-2018-0AM	923340	20x18	\$1000-\$1500	BR83

Whaikaha - Ministry of Disabled People Band 2 & 3 List Equipment

Wheelchairs & Seating

Deep Contour Back Support					Band 2
			SPECIFICATIONS		
			Varilite Icon Deep Air-foam cushion, aluminium shell, Varilock metal mounting hardware that allows for 20° back angle adjustment.		
SUPPLIER			STANDARD HARDWARE		
Allied Medical			Varilock steel hardware (single mount per side) Closed Bracket		
BRAND			MAX USER WEIGHT		
Varilite			136 Kg		
SUPPLIER PRODUCT ID	JDE#	SIZE	PRICE BREAK	ORDERING CODE	
VL440042141	812658	14x17	\$750-\$1000	BR87	
VL440042161	812666	16x18.2	\$750-\$1000	BR88	
VL440042171	812674	17x20.5	\$750-\$1000	BR89	
VL440042181	812682	18x21.75	\$750-\$1000	BR90	
VL440042201	812691	20x23.6	\$750-\$1000	BR91	

Deep Contour Back Support					Band 2
			SPECIFICATIONS		
			Nxt Xtend Deep - Height Adjustable (Active Plus) Width adjustable mounting hardware with one-hand quick release bar		
SUPPLIER			STANDARD HARDWARE		
Morton & Perry			Quickfit Cane and back brackets		
BRAND			MAX USER WEIGHT		
Nxt Xtend					
SUPPLIER PRODUCT ID	JDE#	SIZE	PRICE BREAK	ORDERING CODE	
XDNHAPCB1616/20	845687	16x16-20	\$1000-\$1500	BR84	
XDNHAPCB1816/20	923358	18x16-20	\$750-\$1000	BR85	
XDNHAPCB2016/20	869179	20x16-20	\$1000-\$1500	BR86	

Whaikaha - Ministry of Disabled People Band 2 & 3 List Equipment

Wheelchairs & Seating

Deep Contour Back Support				Band 2
		SPECIFICATIONS		
		Zygo Deep Contour Supportive foam unit, outer anti-shear breathable cover, contoured aluminium shell, positioning wedges, modesty flap.		
SUPPLIER		STANDARD HARDWARE		
Medifab		Drop Mount		
BRAND		MAX USER WEIGHT		
Zygo		136 kg		
SUPPLIER PRODUCT ID	JDE#	SIZE	PRICE BREAK	ORDERING CODE
1251-1011-0DM	923374	10x11	\$1000-\$1500	BR100
1251-1207-0DL	923382	12x7	\$1000-\$1500	BR101
1251-1212-0DM	923391	12x12	\$1000-\$1500	BR102
1251-1213-0DM	923403	12x13	\$1000-\$1500	BR103
1251-1408-0DL	923411	14x8	\$1000-\$1500	BR104
1251-1415-0DM	923420	14x15	\$1000-\$1500	BR105
1251-1416-0DM	923438	14x16	\$1000-\$1500	BR106
1251-1609-0DL	923446	16x9	\$1000-\$1500	BR107
1251-1616-0DM	923454	16x16	\$1000-\$1500	BR108
1251-1617-0DM	923462	16x17	\$1000-\$1500	BR109
1251-1809-0DL	923471	18x9	\$1000-\$1500	BR110
1251-1817-0DM	923489	18x17	\$1000-\$1500	BR111
1251-1818-0DM	923497	18x18	\$1000-\$1500	BR112
1251-2011-0DL	923500	20x11	\$1000-\$1500	BR113

Whaikaha - Ministry of Disabled People Band 2 & 3 List Equipment

Wheelchairs & Seating

Deep Contour Back Support					Band 2
			SPECIFICATIONS		
			ROHO Agility Max (7'') Contour Shell, dual layer foam cushion with air insert, polyester cover		
SUPPLIER			STANDARD HARDWARE		
Permobil			Quick Release		
BRAND			MAX USER WEIGHT		
ROHO					
SUPPLIER PRODUCT ID	JDE#	SIZE	PRICE BREAK	ORDERING CODE	
BR4041	851876	14x16	\$1000-\$1500	BR92	
BR4042	866381	14x18	\$1000-\$1500	BR93	
BR4045	847199	16x18	\$1000-\$1500	BR94	
BR4046	860801	16x20	\$1000-\$1500	BR95	
BR4048	854399	18x18	\$1000-\$1500	BR96	
BR4049	856896	18x20	\$1000-\$1500	BR97	
BR4051	923366	20x18	\$1000-\$1500	BR98	
BR4052	879861	20x20	\$1000-\$1500	BR99	

Modular Back Support					Band 3
			SPECIFICATIONS		
			Vicair Nxt Contour Width adjustable mounting hardware with one-hand quick release bar		
SUPPLIER			STANDARD HARDWARE		
Morton & Perry			Quickfit Cane and back brackets		
BRAND			MAX USER WEIGHT		
Vicair					
SUPPLIER PRODUCT ID	JDE#	SIZE	PRICE BREAK	ORDERING CODE	
XDNVC/1620	902565	16x20	\$1000-\$1500	BR114	
XDNVC/1820	897946	18x20	\$1000-\$1500	BR115	
XDNVC/2020	869363	20x20	\$1000-\$1500	BR116	

Whaikaha - Ministry of Disabled People Band 2 & 3 List Equipment

Wheelchairs & Seating

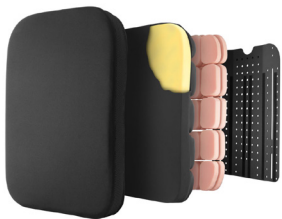
Modular Back Support				Band 3
		SPECIFICATIONS		
		Spex Straight Shaped Spex contouring cell cube foam unit, outer anti-shear breathable cover, aluminium shell, positioning wedges.		
SUPPLIER		STANDARD HARDWARE		
Medifab		Quad Mount		
BRAND		MAX USER WEIGHT		
Spex		Up to 15" wide, 90kg; 16-20" wide, 136kg		
SUPPLIER PRODUCT ID	JDE#	SIZE	PRICE BREAK	ORDERING CODE
1255-1012-OSS	899714	10x12	\$1500-\$2000	BR117
1255-1014-OSS	852676	10x14	\$1500-\$2000	BR118
1255-1016-OSS	887730	10x16	\$1500-\$2000	BR119
1255-1214-OSS	852561	12x14	\$1500-\$2000	BR120
1255-1216-OSS	853071	12x16	\$1500-\$2000	BR121
1255-1218-OSS	854823	12x18	\$1500-\$2000	BR122
1255-1416-OSS	845142	14x16	\$1500-\$2000	BR123
1255-1418-OSS	851155	14x18	\$1500-\$2000	BR124
1255-1420-OSS	851260	14x20	\$1500-\$2000	BR125
1255-1618-OSS	842620	16x18	\$1500-\$2000	BR126
1255-1620-OSS	849215	16x20	\$1500-\$2000	BR127
1255-1623-OSS	850128	16x23	\$1500-\$2000	BR128
1255-1818-OSS	851657	18x18	\$1500-\$2000	BR129
1255-1820-OSS	849531	18x20	\$1500-\$2000	BR130
1255-1823-OSS	852895	18x23	\$1500-\$2000	BR131
1255-2018-OSS	852781	20x18	\$1500-\$2000	BR132
1255-2020-OSS	844879	20x20	\$1500-\$2000	BR133
1255-2023-OSS	853388	20x23	\$1500-\$2000	BR134
1258-2220-OSS	924107	22x20	\$1500-\$2000	BR171
1258-2420-OSS	924115	24x20	\$1500-\$2000	BR172
1258-2620-OSS	924123	26x20	\$1500-\$2000	BR173

Whaikaha - Ministry of Disabled People Band 2 & 3 List Equipment

Wheelchairs & Seating

Modular Back Support				Band 3
		SPECIFICATIONS		
		Spex T Shaped Spex T-Shape contouring cell cube foam unit, outer anti-shear breathable cover, aluminium shell with T-Shape plates, positioning wedges.		
SUPPLIER		STANDARD HARDWARE		
Medifab		Quad Mount		
BRAND		MAX USER WEIGHT		
Spex		Up to 15" wide, 90kg; 16-20" wide, 136kg		
SUPPLIER PRODUCT ID	JDE#	SIZE	PRICE BREAK	ORDERING CODE
1255-1012-0TS	845193	10x12	\$1000-\$1500	BR135
1255-1014-0TS	872571	10x14	\$1000-\$1500	BR136
1255-1016-0TS	849434	10x16	\$1000-\$1500	BR137
1255-1214-0TS	737791	12x14	\$1000-\$1500	BR138
1255-1216-0TS	737803	12x16	\$1000-\$1500	BR139
1255-1218-0TS	737811	12x18	\$1000-\$1500	BR140
1255-1416-0TS	737820	14x16	\$1000-\$1500	BR141
1255-1418-0TS	737838	14x18	\$1000-\$1500	BR142
1255-1420-0TS	737846	14x20	\$1000-\$1500	BR143
1255-1618-0TS	737854	16x18	\$1000-\$1500	BR144
1255-1620-0TS	737862	16x20	\$1000-\$1500	BR145
1255-1623-0TS	737871	16x23	\$1000-\$1500	BR146
1255-1818-0TS	737918	18x18	\$1000-\$1500	BR147
1255-1820-0TS	737926	18x20	\$1000-\$1500	BR148
1255-1823-0TS	737934	18x23	\$1000-\$1500	BR149
1255-2018-0TS	737942	20x18	\$1000-\$1500	BR150
1255-2020-0TS	737951	20x20	\$1000-\$1500	BR151
1255-2023-0TS	737969	20x23	\$1000-\$1500	BR152

Whaikaha - Ministry of Disabled People Band 2 & 3 List Equipment

Wheelchairs & Seating

Bariatric Active Contour Back Support				Band 3
		SPECIFICATIONS		
		Nxt Xtend Height Adjustable (Active) Bariatric Width adjustable mounting hardware with one-hand quick release bar		
SUPPLIER		STANDARD HARDWARE		
Morton & Perry		Quickfit Cane and back brackets		
BRAND		MAX USER WEIGHT		
Nxt Xtend				
SUPPLIER PRODUCT ID	JDE#	SIZE	PRICE BREAK	ORDERING CODE
XDNHAACB2216/20	923518	22x16-20	\$750-\$1000	BR153
XDNHAACB2416/20	923526	24x16-20	\$750-\$1000	BR154

Bariatric Deep Contour Back Support				Band 3
		SPECIFICATIONS		
		Nxt Xtend Deep Height Adjustable (Active Plus) Bariatric Width adjustable mounting hardware with one-hand quick release bar		
SUPPLIER		STANDARD HARDWARE		
Morton & Perry		Quickfit Cane and back brackets,		
BRAND		MAX USER WEIGHT		
Nxt Xtend				
SUPPLIER PRODUCT ID	JDE#	SIZE	PRICE BREAK	ORDERING CODE
XDNHAPCB2216/20	923542	22x16 - 20	\$750-\$1000	BR155
XDNHAPCB2416/20	923551	24x16 - 20	\$750-\$1000	BR156

Whaikaha - Ministry of Disabled People Band 2 & 3 List Equipment

Wheelchairs & Seating

Bariatric Deep Contour Back Support

Band 3



SPECIFICATIONS

Matrx Elite Deep HD
Reinforced aluminium backrest shell
Headrest interface plate
Foam back cushion
Meshtex moisture resistant cover
Basic adjustable lumbar pad

SUPPLIER

Invacare

STANDARD HARDWARE

Quick-release HD Easyset

BRAND

Matrx

MAX USER WEIGHT

SUPPLIER PRODUCT ID	JDE#	SIZE	PRICE BREAK	ORDERING CODE
EDB2118-HD	923569	21x18	\$1500-\$2000	BR157
EDB2120-HD	923577	21x20	\$1500-\$2000	BR158
EDB2218-HD	923585	22x18	\$1500-\$2000	BR159
EDB2220-HD	923593	22x20	\$1500-\$2000	BR160
EDB2318-HD	923606	23x18	\$1500-\$2000	BR161
EDB2320-HD	923614	23x20	\$1500-\$2000	BR162
EDB2418-HD	923622	24x18	\$1500-\$2000	BR163
EDB2420-HD	923631	24x20	\$1500-\$2000	BR164

Whaikaha - Ministry of Disabled People Band 2 & 3 List Equipment

Wheelchairs & Seating

Wheelchair Paediatric Folding Frame Fully Configurable

Band 2



DESCRIPTION

Action 3 Junior Folding Frame

Base unit includes:

Action 3 Junior

- Wheelchair sizes: 8-11x10-12, 8-11x12-14, 12-15x11-13, 12-15x13-15
- Available in two colours – Matte Red and Polar Blue
- Self Propelling (22" rear wheel)
- Front castor Wheels 5"
- Leg rest hangers available in 80 degree swing away or 90 degree
- Footrests Flip Up Angle and Depth adjustable
- Seat Upholstery Nylon adjustable
- Back Upholstery Nylon adjustable
- Back Canes fixed height 0 degree
- Armrests removable height adjustable with skirt guard
- Push to Lock Brakes
- Seat Belt
- Anti-Tippers

Accessories JDE number 902346

SUPPLIER

Invacare

ASSESSOR ACCREDITATION

WMPML1, WMPML1P, WMPML2, WMPML2P

BRAND

Action 3 Junior

MAX USER WEIGHT

80kg

DESCRIPTION	SUPPLIER PRODUCT ID	JDE#	SEAT SIZE (width x depth)	PRICE BREAK	ORDERING CODE
Action 3 Junior Self Propelled base unit	EF1672195	902371	8-11x10-12	\$1500-\$2000	WC328
	EF1672197	902362	8-11x12-14		WC329
	EF1672199	902354	12-15x11-13		WC330
	EF1672200	848132	12-15x13-15		WC331
Action 3 Junior Self Propelled base unit		902338	Fully Scripted		WC332

Requests for this item MUST include:

* Enable New Zealand's Manual Wheelchair Specification Form

Whaikaha - Ministry of Disabled People Band 2 & 3 List Equipment

Wheelchairs & Seating

Wheelchair Standard Minimal-Adjustable		Band 2			
		DESCRIPTION			
		Karma Flexx Folding Base unit includes: Karma Flexx Wheelchair sizes: 14x16, 16x16, 16x18, 16x20, 18x16, 18x18, 18x20 <ul style="list-style-type: none"> • Standard seat and back upholstery • 7" castor • 24" pneumatic rear wheel with quick release axle (Self Propelled) or 14" rear wheel (Transit) • Height adjustable, flip back desk armrest • Calf strap • 80 deg legrests with fixed angle foot rest • 2point hip belt • Back angle adjustment (-4° to +16°) • Removable antitipper • Push to lock brakes • Fixed back canes Flexx height 17" • Fixed back canes Flexx Tall height 20" Option extra adjustable Back Canes <ul style="list-style-type: none"> • Adjustable back canes 15-20" Accessories JDE number 891448			
SUPPLIER		ASSESSOR ACCREDITATION			
Allied Medical Ltd		WMPML1, WMPML1P, WMPML2, WMPML2P			
BRAND		MAX USER WEIGHT			
Karma		Karma Flexx 130kg			
DESCRIPTION	SUPPLIER PRODUCT ID	JDE#	SEAT SIZE (width x depth)	PRICE BREAK	ORDERING CODE
Karma Flexx Transit base unit	KMFLEXXSTR1416	897444	14x16	\$1000-\$1500	WC302
	KMFLEXXSTR1616	880600	16x16		WC303
	KMFLEXXSTR1618	879756	16x18		WC304
	KMFLEXXSTR1816	897452	18x16		WC305
	KMFLEXXSTR1818	897461	18x18		WC306
Karma Flexx Tall Transit base unit	KMFLEXXTLTR1620	875181	16x20		WC307
	KMFLEXXTLTR1820	897479	18x20		WC308
Karma Flexx Self Propelled base unit	KMFLEXXSP1416	897524	14x16		WC309
	KMFLEXXSP1616	874816	16x16		WC310
	KMFLEXXSP1618	878198	16x18		WC311
	KMFLEXXSP1816	876774	18x16		WC312
	KMFLEXXSP1818	869224	18x18	WC313	
Karma Flexx Tall Self Propelled base unit	KMFLEXXTLSP1620	874664	16x20	WC314	
	KMFLEXXTLSP1820	875122	18x20	WC315	
Karma Flexx base unit		891430	Fully Scripted		WC275
Requests for this item MUST include: * Enable New Zealand's Manual Wheelchair Specification Form					

Whaikaha - Ministry of Disabled People Band 2 & 3 List Equipment

Wheelchairs & Seating

Wheelchair Standard Minimal-Adjustable

Band 2



DESCRIPTION

Karma Flexx HD
Folding

Base unit includes:

Karma Flexx HD

Wheelchair sizes: 20x18, 20x20, 22x18, 22x20, 24x18, 24x20

- Standard seat and back upholstery
- 7" castor
- 24" pneumatic rear wheel with quick release axle (Self Propelled) or 14" rear wheel (Transit)
- Height adjustable, flip back desk armrest
- Heel loops
- 80 deg legrests with fixed angle foot rest
- 2point hip belt
- Back angle adjustment (-4° to +16°)
- Removable antitipper
- Push to lock brakes
- Rigidising Bar (which doubles as a push handle)
- Fixed back canes Flexx HD height 17"

Option extra adjustable Back Canes

- Adjustable back canes 15-20"

Accessories JDE number 891448

SUPPLIER

Allied Medical Ltd

ASSESSOR ACCREDITATION

WMPML1, WMPML1P, WMPML2, WMPML2P

BRAND

Karma

MAX USER WEIGHT

Karma Flexx HD 170kg

DESCRIPTION	SUPPLIER PRODUCT ID	JDE#	SEAT SIZE (width x depth)	PRICE BREAK	ORDERING CODE
Karma Flexx HD Transit base unit	KMFLEXXHDTR2018	890912	20x18	\$1500-\$2500	WC316
	KMFLEXXHDTR2020	897487	20x20		WC317
	KMFLEXXHDTR2218	897495	22x18		WC318
	KMFLEXXHDTR2220	889250	22x20		WC319
	KMFLEXXHDTR2418	897508	24x18		WC320
	KMFLEXXHDTR2420	897516	24x20		WC321
Karma Flexx HD Self Propelled base unit	KMFLEXXHDSP2018	881872	20x18		WC322
	KMFLEXXHDSP2020	875229	20x20		WC323
	KMFLEXXHDSP2218	889479	22x18		WC324
	KMFLEXXHDSP2220	889410	22x20		WC325
	KMFLEXXHDSP2418	892766	24x18		WC326
	KMFLEXXHDSP2420	879537	24x20		WC327
Karma Flexx HD base unit		891430	Fully Scripted		WC275

Requests for this item MUST include:

- * Enable New Zealand's Manual Wheelchair Specification Form

Whaikaha - Ministry of Disabled People Band 2 & 3 List Equipment

Wheelchairs & Seating

Wheelchair Paediatric Rigid Frame - Growable

Band 3



DESCRIPTION

Kea

Base unit includes;

Melrose Kea

Frame sizes 8-15x8-16 (including growth)

- Growth 2-3" width (depending on chair size)
- Growth 2-3" depth (depending on chair size)
- One piece flip back, or fixed angle adjustable foot-plate
- 4, 5 or 6" castors, narrow or wide plastic hub
- Push handles in back canes or stroller handle can be fitted
- Push to lock brakes
- Anti-tips
- Standard wheel sizes: 12.5" transit, 16" or 22" composite,
- 18" 20" or 22" spoked wheels
- Various options of tyre – depending on size (either std 1 3/8, HP tread or smooth, or solid)
- Standard sling and tension adjustable back upholstery and fabric skirt guards
- Child seat belt with Plastic buckle
- Leg strap or heel loops
- Impact guards
- Colour: Red, Blue, Silver or black

Accessories JDE number 902397

SUPPLIER

Melrose

ASSESSOR ACCREDITATION

WMPML2, WMPML2P

BRAND

Melrose Kea

MAX USER WEIGHT

60kg

DESCRIPTION	SUPPLIER PRODUCT ID	JDE#	SEAT SIZE (width x depth)	PRICE BREAK	ORDERING CODE
Kea Self Propelled base unit	90700	832317	8-15x8-16 (inc growth)	\$3500-\$4000	WC334

Requests for this item MUST include:

* Enable New Zealand's Manual Wheelchair Specification Form

Whaikaha - Ministry of Disabled People Band 2 & 3 List Equipment

Wheelchairs & Seating

Wheelchair Paediatric Rigid Frame Growable

Band 3



DESCRIPTION

TiLite Twist

Base unit includes:

TiLite Twist

Frame sizes 8-15x 8-16 with 3" adjustment width and depth

- Available in 4 colours Red, Blue, Black, Silver and Black Anodized accessories
- 70, 80 or 90° Front Frame Angle
- Angle Adjustable Footplate
- Folding Back Canes that Lock when Folded
- Integrated Adjustable Height Push Handles
- 0 - 12° Camber
- 4x0.75" or 5x1" Castors
- 18-24" TiLite Shadow Wheels
- Pneumatic Treaded or Slick Tyres
- Aluminium Silver or Black Long Tab Pushrims
- Push or Pull to Lock Brakes
- Velcro Adjustable Back and Seat Upholstery

Accessories JDE number 902389

SUPPLIER

Permobil

ASSESSOR ACCREDITATION

WMPML2, WMPML2P

BRAND

TiLite

MAX USER WEIGHT

75kg

DESCRIPTION	SUPPLIER PRODUCT ID	JDE#	SEAT SIZE (width x depth)	PRICE BREAK	ORDERING CODE
TiLite Twist Self Propelled base unit	TWFS2	847068	8-15x8-16	\$3500-\$4000	WC333

Requests for this item MUST include:

* Enable New Zealand's Manual Wheelchair Specification Form

Whaikaha - Ministry of Disabled People Band 2 & 3 List Equipment

Wheelchairs & Seating

Wheelchair Paediatric Folding Frame Growable

Band 3



DESCRIPTION

Melrose Condor Junior

Base Unit Includes:

Melrose Condor Junior

- Frame sizes available between 8" – 14" (adult version starts at 14")
- (Ability to grow width with growth kit)
- Seat depth between 8" – 14" with growth of 2 or 3" built in
- Swing away leg rest
- 4, 5 or 6" castors, narrow or wide plastic hub
- Push handles in back canes if required
- Push to lock brakes
- Anti-tips
- Standard wheel sizes: 12.5" transit, 16" or 22" composite,
- 18" 20" or 22" spoked wheels
- Various options of tyre – depending on size (either std 1 3/8, HP tread or smooth, or solid)
- Standard sling and tension adjustable back upholstery and fabric skirt guards
- Child seat belt with Plastic buckle
- Leg strap or heel loops if required
- Impact guards
- Colour: Red, Blue, Silver or black

Accessories JDE number 902426

SUPPLIER

Melrose Kiwi Concept Chairs

ASSESSOR ACCREDITATION

WMPML2, WMPML2P

BRAND

Melrose Condor Junior

MAX USER WEIGHT

60kg

DESCRIPTION	SUPPLIER PRODUCT ID	JDE#	SEAT SIZE (width x depth)	PRICE BREAK	ORDERING CODE
Melrose Condor Junior Self Propelled base unit	90050	902451	8-14x8-14	\$3500-\$4000	WC339

Requests for this item MUST include:

* Enable New Zealand's Manual Wheelchair Specification Form

Whaikaha - Ministry of Disabled People Band 2 & 3 List Equipment

Wheelchairs & Seating

Wheelchair Fully Configurable

Band 3



DESCRIPTION

Condor
Folding

Base unit includes:

Condor Aluminium

Frame sizes: 14-20x16-22 in inch increments

- Swing away legrest with plastic footplates
- Dropin or fixed front
- 4,5 or 6" castor, narrow or wide with plastic hub
- Push handles in back cane
- Push to lock brakes
- Anti-tips
- Standard wheel sizes 12 to 26"
- Standard Sling and Tension adjustable back upholstery
- Leg strap or heel loops
- Impact guards
- Colour Red, blue, black or silver

Condor Titanium

Frame sizes: 14-20x16-22 in inch increments

- Swing away legrest with plastic footplates
- Dropin or fixed front
- 4,5 or 6" castor, narrow or wide with plastic hub
- Push handles in back cane
- Push to lock brakes
- Anti-tips
- Standard wheel sizes 12 to 26"
- Standard Sling and Tension adjustable back upholstery
- Leg strap or heel loops
- Impact guards
- Colour standard titanium finish

Accessories JDE number 891472

SUPPLIER		ASSESSOR ACCREDITATION		
Melrose		WMPML2, WMPML2P		
BRAND		MAX USER WEIGHT		
Condor		125kg		
DESCRIPTION	JDE#	SEAT SIZE (width x depth)	PRICE BREAK	ORDERING CODE
Condor Aluminium base unit	891456	14-20x16-22	\$3500-\$4000	WC276
Condor Titanium base unit	891464	14-20x16-22	\$6500-\$7000	WC277

Requests for this item MUST include:

* Enable New Zealand's Manual Wheelchair Specification Form

Whaikaha - Ministry of Disabled People Band 2 & 3 List Equipment

Wheelchairs & Seating

Wheelchair Fully Configurable		Band 3		
		DESCRIPTION		
		Quickie 2 Folding Base unit includes: Quickie 2 <ul style="list-style-type: none"> • DAB depth & angle adjustable backrest • 24" lite spoke rear wheels • Anodised push rims • Marathon plus tyres • 5" x 1.5" semi-pneumatic castors • Single post height adjustable armrests with full length pads • 80 degree swingaway footrest hangers • Aluminium angle adjustable footplates • 16" high 3DX tension adjustable • back upholstery • Integrated push handles • Anti-tips • Colour is black opal <p style="text-align: right;">Accessories JDE number 891528</p>		
SUPPLIER		ASSESSOR ACCREDITATION		
Medifab		WMPML2, WMPML2P		
BRAND		MAX USER WEIGHT		
Quickie		136kg standard and 158kg heavy duty		
DESCRIPTION	JDE#	SEAT SIZE (width x depth)	PRICE BREAK	ORDERING CODE
Quickie 2 base unit	891481	12-19x12-19	\$3500-\$4000	WC278
Quickie 2 base unit	891499	12-19x20 and 20x12-19	\$5000-\$5500	WC279
Quickie 2 base unit	891501	20x20	\$5500-\$6000	WC280
Quickie 2 base unit	891510	Fully Scripted		WC281
Requests for this item MUST include: * Enable New Zealands Manual Wheelchair Specification Form				

Whaikaha - Ministry of Disabled People Band 2 & 3 List Equipment

Wheelchairs & Seating

Wheelchair Fully Configurable		Band 3		
		DESCRIPTION		
		TiLite AeroX Folding Base unit includes: AeroX <ul style="list-style-type: none"> • Swingaway Legrests 85 deg standard, also available in 70, 80 and 90 deg, as well as fixed front end • Composite Flip Up Footplates height adjustable • Composite Casters either 4, 5, or 6" • Composite Push or Pull 2 Lock Brakes • Seat upholstery and padded backrest upholstery • adjustable slide in seat sling • Height Adjustable Fixed Angle Back Canes 90 deg or with 8 deg bend • Integrated Push Handles • TiLite Shadow Rear Wheel 22", 24", 25" or 26" • Silver Anodized Handrim • Tyre Treaded or Smooth • TiLite Stainless Quick Release Axles • Camber 0, 2, 4, 6 deg • Fully adjustable seat-to-floor heights and centre of gravity • Colour red, blue, black or silver <p style="text-align: right;">Accessories JDE number 891536</p>		
SUPPLIER		ASSESSOR ACCREDITATION		
Permobil		WMPML2, WMPML2P		
BRAND		MAX USER WEIGHT		
Ti		120kg standard and 159kg heavy duty		
DESCRIPTION	JDE#	SEAT SIZE (width x depth)	PRICE BREAK	ORDERING CODE
TiLite AeroX base unit	891544	12-22x12-20	\$3000-\$3500	WC282
Requests for this item MUST include: * Enable New Zealands Manual Wheelchair Specification Form				

Whaikaha - Ministry of Disabled People Band 2 & 3 List Equipment

Wheelchairs & Seating

Wheelchair with Tilt		Band 3		
		DESCRIPTION		
		<p>Quickie Iris Rigid</p> <p>Base unit includes:</p> <p>Quickie Iris Medium Frame sizes: 14-20x16-20</p> <ul style="list-style-type: none"> • True-ft growth system • Tie downs • Width adjusting system • Medium seat frame • 6" x 1.5" semi pneumatic front castors • 16" Rear mag wheels; pneumatic • 80° legrest hangers with angle adjustable footplates • Single post height adjustable arm supports with full length pads • Height adjustable push handle • Growable seat pan • Anti-tips • Black Opal frame colour • Foot operated tilt and brakes <p>Quickie Iris Long Frame sizes: 14-20x18-22</p> <ul style="list-style-type: none"> • True-ft growth system • Tie downs • Width adjusting system • Long seat frame • 6" x 1.5" semi pneumatic front castors • 16" Rear mag wheels; pneumatic • 80° legrest hangers with angle adjustable footplates • Single post height adjustable arm supports with full length pads • Height adjustable push handle • Growable seat pan • Anti-tips • Black Opal frame colour • Foot operated tilt and brakes <p style="text-align: right;">Accessories JDE number 889006</p>		
SUPPLIER		ASSESSOR ACCREDITATION		
Medifab		WMPML1, WMPML1P, WMPML2, WMPML2P		
BRAND		MAX USER WEIGHT		
Quickie		136kg standard and 181kg heavy duty		
DESCRIPTION	JDE#	SEAT SIZE (width x depth)	PRICE BREAK	ORDERING CODE
Quickie Iris Medium base unit	889014	14-20x16-20	\$5000-\$5500	WC283
Quickie Iris Long base unit	889022	14-20x18-22	\$5500-\$6000	WC284
<p>Requests for this item MUST include:</p> <p>* Enable New Zealand's Manual Wheelchair Specification Form</p>				

Whaikaha - Ministry of Disabled People Band 2 & 3 List Equipment

Wheelchairs & Seating

Wheelchair with Tilt

Band 3



DESCRIPTION

Zippie Iris
Rigid

Base unit includes:

Zippie Iris

Frame sizes: 10-14x10-18

- True-ft growth system
- Tie downs
- Width adjusting system
- Short, medium and long seat frame
- 5" x 1.5" semi pneumatic front castors
- 16" Rear mag wheels; pneumatic
- 90° legrest hangers with angle adjustable footplates
- Offset hanger mounts
- Single post height adjustable arm supports with full length pads
- Height adjustable push handle
- Growable seat pan
- Anti-tips
- Black Opal frame colour
- Foot operated tilt
- Foot operated brakes

Accessories JDE number 888994

SUPPLIER

Medifab

ASSESSOR ACCREDITATION

WMPML1, WMPML1P, WMPML2, WMPML2P

BRAND

Quickie

MAX USER WEIGHT

102kg

DESCRIPTION	JDE#	SEAT SIZE (width x depth)	PRICE BREAK	ORDERING CODE
Zippie Iris base unit	888986	10-14x10-18	\$4000-\$4500	WC285

Requests for this item MUST include:

* Enable New Zealand's Manual Wheelchair Specification Form

Whaikaha - Ministry of Disabled People Band 2 & 3 List Equipment

Wheelchairs & Seating

Wheelchair with Tilt		Band 3		
		DESCRIPTION		
		Solara 3G Rigid Base unit includes: Solara 3G Frame sizes: 12-24x12-22 <ul style="list-style-type: none"> • Width and Depth Adjustable Frame • Tilt in Space Frame • Stroller Handles • Foot operated brake • Foot operated tilt • 12" or 24" Rear Wheels • 70 Degree Swingaway Legrests with angle adjustable footplates • Dual post flip back, height adjustable armrest with full length armpad • 2 Point Freedom belt • Tie Downs • Colour Black 		
		Accessories JDE number 891579		
SUPPLIER		ASSESSOR ACCREDITATION		
Invacare		WMPML1, WMPML1P, WMPML2, WMPML2P		
BRAND		MAX USER WEIGHT		
Solara		136kg		
DESCRIPTION	JDE#	SEAT SIZE (width x depth)	PRICE BREAK	ORDERING CODE
Solara 3G base unit	891552	12-24x12-22	\$4500-\$5000	WC286
Requests for this item MUST include: * Enable New Zealand's Manual Wheelchair Specification Form				

Whaikaha - Ministry of Disabled People Band 2 & 3 List Equipment

Wheelchairs & Seating

Wheelchair Rigid - Box Style

Band 3



DESCRIPTION

Stallion
Rigid

Base unit includes:

Stallion Aluminium

Frame sizes: 14-20x14-20 in inch increments

- Swing away legrest with plastic footplates
- Dropin or fixed front
- 4,5 or 6" castor, narrow or wide with plastic hub
- Push to lock brakes
- Anti-tips
- Standard wheel sizes 12 to 26"
- Standard Sling and Tension adjustable back upholstery
- Leg strap or heel loops
- Impact gaurds
- Colour Red, blue, black or silver

Stallion Titanium

Frame sizes: 14-20x14-20 in inch increments

- Swing away legrest with plastic footplates
- Dropin or fixed front
- 4,5 or 6" castor, narrow or wide with plastic hub
- Push to lock brakes
- Anti-tips
- Standard wheel sizes 12 to 26"
- Standard Sling and Tension adjustable back upholstery
- Leg strap or heel loops
- Impact gaurds
- Colour standard titanium finish

Accessories JDE number 891587

SUPPLIER

Melrose

ASSESSOR ACCREDITATION

WMPML2, WMPML2P

BRAND

Stallion

MAX USER WEIGHT

14 to 16 115kg 18+ 165kg

DESCRIPTION	JDE#	SEAT SIZE (width x depth)	PRICE BREAK	ORDERING CODE
Stallion Aluminium base unit	891595	14-20x14-20	\$3500-\$4000	WC287
Stallion Titanium base unit	891608	14-20x14-20	\$7000-\$7500	WC288

Requests for this item MUST include:

* Enable New Zealand's Manual Wheelchair Specification Form

Whaikaha - Ministry of Disabled People Band 2 & 3 List Equipment

Wheelchairs & Seating

Wheelchair Rigid - Z Style

Band 3



DESCRIPTION

Ki Rogue
Rigid

Base unit includes:

Ki Rogue XP Growable

Frame sizes: 10-18x10-19 with up to 3inch built in depth adjustment

- Fixed frame with built in growth, straight or tapered tubular open footplate
- Selection of 70,75,80 or 85 degree frame bend.
- 3,4,5 or 6" x 1 poly castor
- Standard seat upholstery and padded backrest upholstery
- Height adjust back canes
- 18,20,22,24 or 25 " std spoke wheels options with Aluminum Anodised Pushrims, Street pneumatic tyres, Quick release axles
- Brake options push to lock, push to lock flush mount or pull to lock
- Camber options -0,2,4,6, or 8 deg camber

Ki Rogue

Frame sizes: 12-19x14-19

- Tubular open footplate
- Selection of 70,75,80 or 85
- 3,4,5 or 6" x 1 poly castor
- Standard seat upholstery and padded backrest upholstery
- Height adjust back canes
- 20, 22, 24, 25, 26 standard spoke wheels and Aluminum anodised pushrims, street pneumatic tyres and quick release axles
- Brake options push to lock, push to lock flush mount or pull to lock
- 0,2,4,6, or 8 deg camber

Accessories JDE number 891667

SUPPLIER

Allied Medical

ASSESSOR ACCREDITATION

WMPML2, WMPML2P

BRAND

Ki

MAX USER WEIGHT

Rogue XP 90kg Rogue 125kg

DESCRIPTION	JDE#	SEAT SIZE (width x depth)	PRICE BREAK	ORDERING CODE
Ki Rogue XP Growable base unit	891827	10-18x10-19	\$3500-\$4000	WC291
Ki Rogue base unit	891659	12-19x14-19	\$3000-\$3500	WC292

Requests for this item MUST include:

* Enable New Zealand's Manual Wheelchair Specification Form

Whaikaha - Ministry of Disabled People Band 2 & 3 List Equipment

Wheelchairs & Seating

Wheelchair Rigid - Z Style

Band 3



DESCRIPTION

Hawk
Rigid

Base unit includes:

Hawk Aluminium

Frame sizes: 16-20x16-20 in inch increments

- Fixed front
- 4,5 or 6" castor, narrow or wide with plastic hub
- Push to lock brakes
- Anti-tips
- Standard wheel sizes 24 to 26"
- Standard Sling and Tension adjustable back upholstery
- Leg strap
- Impact guards
- Colour Red, blue, black or silver

Hawk Titanium

Frame sizes: 16-20x16-20 in inch increments

- Fixed front
- 4,5 or 6" castor, narrow or wide with plastic hub
- Push to lock brakes
- Anti-tips
- Standard wheel sizes 24 to 26"
- Standard Sling and Tension adjustable back upholstery
- Leg strap
- Impact guards
- Colour standard titanium finish

Hawk Growable

Frame sizes: 14x13-16

- Fixed front
- 4 or 5" castor, narrow or wide with plastic hub
- Push to lock brakes
- Anti-tips
- Standard wheel sizes 20,22 or 24"
- Standard sling and back upholstery
- Leg strap
- Impact guards
- Colour Red, blue, black or silver

Accessories JDE number 891675

SUPPLIER

Melrose

ASSESSOR ACCREDITATION

WMPML2, WMPML2P

BRAND

Hawk

MAX USER WEIGHT

100kg

DESCRIPTION	JDE#	SEAT SIZE (width x depth)	PRICE BREAK	ORDERING CODE
Hawk Aluminium base unit	891683	16-20x16-20	\$4500-\$5000	WC293
Hawk Titanium base unit	891691	16-20x16-20	\$6000-\$6500	WC294
Hawk Growable base unit	891704	14x13-16	\$5500-\$6000	WC295

Requests for this item MUST include:

* Enable New Zealand's Manual Wheelchair Specification Form

Whaikaha - Ministry of Disabled People Band 2 & 3 List Equipment

Wheelchairs & Seating

Wheelchair Rigid - Z Style		Band 3		
		DESCRIPTION		
		TiLite ZRA Rigid Base unit includes: ZRA <ul style="list-style-type: none"> • Front Frame Angle 85 deg standard, also available in 70, 80 and 90 deg, as well as fixed front end • Footrest Width Taper no taper, 1.5" or 3.5" • Angle Adjustable Footplate height adjustable • Composite Casters 4, 5, or 6" • Composite Push or Pull 2 Lock Brakes • Bolt-On Tension Adj. Seat Upholstery • Padded Backrest Upholstery • Height/Angle adjustable Folding Backrest • Aluminium Back Release Bar • Integrated Push Handles • Aluminium Camber Tube 0, 2, 4, 6 Deg Camber • TiLite Shadow Rear Wheel 20", 22", 24", 25" or 26" • Silver Anodized Handrim • Tyre Treaded or Smooth • TiLite Stainless Quick Release Axles • Camber 0, 2, 4 or 6 deg • Fully adjustable seat-to-floor heights and centre of gravity • Colour red, blue, black or titanium satin <p style="text-align: right;">Accessories JDE number 891721</p>		
SUPPLIER		ASSESSOR ACCREDITATION		
Permobil		WMPML2, WMPML2P		
BRAND		MAX USER WEIGHT		
TiLite		120kg standard and 136kg Heavy Duty		
DESCRIPTION	JDE#	SEAT SIZE (width x depth)	PRICE BREAK	ORDERING CODE
TiLite ZRA base unit	891712	10-20x10-20	\$5000-\$5500	WC296
Requests for this item MUST include: * Enable New Zealand's Manual Wheelchair Specification Form				

Whaikaha - Ministry of Disabled People Band 2 & 3 List Equipment

Wheelchairs & Seating

Wheelchair Bariatric

Band 3



DESCRIPTION

Karma BT10
Folding

Base unit includes:

Karma BT10

Frame sizes: 22x18, 22x20, 24x18, 24x20, 26x20

- Tension adjustable back upholstery
- Solid seat base
- Swingaway 70 degree legrests with angle adjustable footplates
- Flip back armrests fixed height
- Angle adjustable backrest (from -5 degrees to +15 degrees)
- 2 point hip belt
- Calf strap
- Swingaway antitippers
- Basic foam cushion
- Dual brake system attendant brake as well as manual brake on each wheel
- Rear wheel 24" pneumatic
- Castor 7 x 1 3/4"
- Standard seat to floor height 18" (is adjustable)

Accessories JDE number 891739

SUPPLIER

Allied Medical

ASSESSOR ACCREDITATION

WMPML1, WMPML1P, WMPML2, WMPML2P

BRAND

Karma

MAX USER WEIGHT

250kg

DESCRIPTION

JDE#

SEAT SIZE (width x depth)

PRICE BREAK

ORDERING CODE

Karma BT10 base unit

891747

22x18, 22x20, 24x18,
24x20, 26x20

\$3000-\$3500

WC297

Requests for this item MUST include:

* Enable New Zealand's Manual Wheelchair Specification Form

Whaikaha - Ministry of Disabled People Band 2 & 3 List Equipment

Wheelchairs & Seating

Wheelchair Bariatric		Band 3		
		DESCRIPTION		
		Stallion Bariatric Rigid Base unit includes: Stalion Bariatric Frame sizes: 22, 24, 26x18, 20, 22, 24 <ul style="list-style-type: none"> • Swing away or drop in swing away footplates • 5 or 6" castor, narrow or wide with alloy hub • Push to lock brakes • Stainless steel anti-tips • Standard wheel sizes 24" bariatric wheels • Standard Sling and Tension adjustable back upholstery • Leg strap or heel loops • Impact guards • Colour Red, blue, black or silver <p style="text-align: right;">Accessories JDE number 891763</p>		
SUPPLIER		ASSESSOR ACCREDITATION		
Melrose		WMPML2, WMPML2P		
BRAND		MAX USER WEIGHT		
Stallion		250kg		
DESCRIPTION	JDE#	SEAT SIZE (width x depth)	PRICE BREAK	ORDERING CODE
Stallion Bariatric base unit	891755	22,24,26x18,20,22,24	\$4500-\$5000	WC298
Requests for this item MUST include: * Enable New Zealands Manual Wheelchair Specification Form				

Whaikaha - Ministry of Disabled People Band 2 & 3 List Equipment

Wheelchairs & Seating

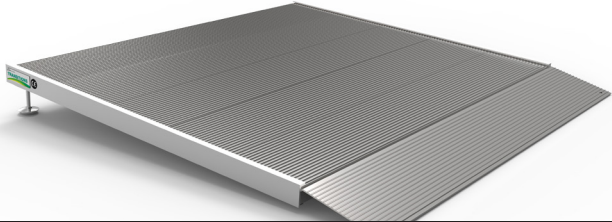
Ramp					Band 2
			SPECIFICATIONS		
			Threshold ramp Aluminium Non-skid surface		
SUPPLIER			DIMENSIONS		
Cubro			900mm width 50-110mm height adjustable		
BRAND			MAX USER WEIGHT		
EuroRamps			317kg		
SUPPLIER PRODUCT ID	JDE#	Length	PRICE BREAK	ORDERING CODE	
772	931809	900mm	Over \$1000	RA18	
773	931817	1720mm	Over \$1000	RA19	

Ramp					Band 2
			SPECIFICATIONS		
			Oversill ramp Two piece aluminium Non-skid surface		
SUPPLIER			DIMENSIONS		
Cubro			760mm width 70-215mm height adjustable		
BRAND			MAX USER WEIGHT		
EuroRamps			300kg		
SUPPLIER PRODUCT ID	JDE#	Length	PRICE BREAK	ORDERING CODE	
555-800MM	760991	800mm + 400mm flap	Over \$1000	RA30	
569-1200MM	760982	1200mm + 500mm flap	Over \$1000	RA31	