



He Kaupare. He Manaaki.
He Whakaora.
prevention. care. recovery.



ACC List Equipment

Simple [\(Pages 2 - 44\)](#)
Standard [\(Pages 45 - 58\)](#)
Complex [\(Pages 59 - 76\)](#)



Version: 26
Issued: 03/08/2023

ACC

Simple List Equipment

Similar item

Similar drop down option will be available for selection if the similar item is in the warehouse for dispatch.

Table of Contents

Ambulatory	3
Bedroom	7
Kitchen & Living	11
Manual Handling	18
Office	20
Shower & Bath	27
Toileting	34
Wheelchairs & Seating	38
Daily Living Aids	40

ACC Simple List Equipment

Ambulatory

Walking Frame - Light Weight				Simple
		SPECIFICATIONS		
		Folding Lightweight aluminium Suitable for indoor use only 610mm overall width 790-920mm adjustable height		
SUPPLIER/BRAND		MAX USER WEIGHT		
Tubular Equipment		160kg		
SUPPLIER PRODUCT ID	ENZ LIST CODE	SPECIFICATIONS	ACC SIC CODE	
AF1101	ENZA118	4 Stoppers	EM042	
AF1103G	ENZA192	Front castors / rear glide feet	EM043	
AF1102G	ENZA135	Front wheels / rear glide feet	EM044	
AF1103	ENZA137	Front castors / rear stoppers	EM045	
AF1102	ENZA126	Front wheels / rear stoppers	EM046	
ACCESSORIES				
DESCRIPTION	ENZ LIST CODE	SUPPLIER PRODUCT ID	ACC SIC CODE	
Basket/tray	ENZA110	BSKT88	EM047	

Walking Frame - Standard				Simple
		SPECIFICATIONS		
		Pacer Front castors / rear wheels and Handbrake Folding Standard with basket and tray Suitable for indoor use only 570mm overall width 755-990mm adjustable handle height		
SUPPLIER/BRAND		MAX USER WEIGHT		
Cubro/Pacer		160kg		
SUPPLIER PRODUCT ID	ENZ LIST CODE	ACC SIC CODE		
1875HB	ENZA127	EM039		

ACC Simple List Equipment

Ambulatory

Walking Frame - Rollator			Simple
		SPECIFICATIONS	
		Super Stroller Narrow Folding Standard with bag Suitable for indoor use only 500mm overall width 750-880mm adjustable handle height 150mm (6 inch) Castor and rear wheel	
SUPPLIER/BRAND		MAX USER WEIGHT	
Cubro/Super Stroller		127kg	
SUPPLIER PRODUCT ID	ENZ LIST CODE	ACC SIC CODE	
1845	ENZA112	EM037	
ACCESSORIES			
DESCRIPTION	ENZ LIST CODE	SUPPLIER PRODUCT ID	ACC SIC CODE
Tray	ENZA50	1944	EM049

Walking Frame - Rollator			Simple
		SPECIFICATIONS	
		Lightweight aluminium Height adjustable seat Standard with bag Suitable for indoor & outdoor use. 8" wheels 590mm overall width 545-620mm adjustable seat height 850-1010mm adjustable handle height	
SUPPLIER/BRAND		MAX USER WEIGHT	
Independent Living Service		136kg	
SUPPLIER PRODUCT ID	ENZ LIST CODE	ACC SIC CODE	
ILS-9288-8	ENZA105	EM035	
ACCESSORIES			
DESCRIPTION	ENZ LIST CODE	SUPPLIER PRODUCT ID	ACC SIC CODE
Tray	ENZA31	ILS-9288-TR	EM048

ACC Simple List Equipment

Ambulatory

Walking Frame - Gutter			Simple
		SPECIFICATIONS	
		Adjustable forearm support Front castors / rear wheels and Handbrake Suitable for indoor use only 475mm overall width 800-1250mm adjustable handle height 150mm (6 inch) Castor and wheels	
SUPPLIER/BRAND		MAX USER WEIGHT	
Cubro/Pacer		160kg	
SUPPLIER PRODUCT ID	ENZ LIST CODE	ACC SIC CODE	
1905HB	ENZA180	EM029	

Walking Stick			Simple
		SPECIFICATIONS	
		Crook handle 760-995mm adjustable height	
SUPPLIER/BRAND		MAX USER WEIGHT	
Cubro/Mobilis		127kg	
SUPPLIER PRODUCT ID	ENZ LIST CODE	ACC SIC CODE	
1704BL	ENZA21	EM040	

Walking Stick			Simple
		SPECIFICATIONS	
		Swan handle 780-1016mm adjustable height	
SUPPLIER/BRAND		MAX USER WEIGHT	
Allied Medical Ltd		125kg	
SUPPLIER PRODUCT ID	ENZ LIST CODE	ACC SIC CODE	
MP10602B	ENZA17	EM041	

ACC Simple List Equipment

Ambulatory

Elbow Crutch			Simple
		SPECIFICATIONS	
		Double adjustable (Pair) Comfy Handle 630mm-860mm adjustable height handle to floor 240mmx320mm adjustable height handle to top of cuff	
SUPPLIER/BRAND		MAX USER WEIGHT	
Allied Medical Ltd		115kg	
SUPPLIER PRODUCT ID	ENZ LIST CODE	ACC SIC CODE	
MP10403	ENZA24	EM001	

Elbow Crutch			Simple
		SPECIFICATIONS	
		Double adjustable (Pair) 200-270mm adjustable height armband to grip 670-920mm adjustable height handgrip to ground	
SUPPLIER/BRAND		MAX USER WEIGHT	
Cubro/Coopers		180kg	
SUPPLIER PRODUCT ID	ENZ LIST CODE	ACC SIC CODE	
1742	ENZA25	EM002	

Knee Walker			Simple
		SPECIFICATIONS	
		Knee Walker Basket Handle & Crutch holder set with mounting hardware Height:Max 500mm Height Min: 790mm	
SUPPLIER/BRAND		MAX USER WEIGHT	
Cubro/Freiheit		130kg	
SUPPLIER PRODUCT ID	ENZ LIST CODE	ACC SIC CODE	
1549	ENZA142	EM005	

ACC Simple List Equipment

Bedroom

Backrest			Simple
		SPECIFICATIONS	
		Standard single webbed 610mm width 510mm depth 25-65 degree angle position	
SUPPLIER/BRAND		MAX USER WEIGHT	
Allied Medical Ltd		100kg	
SUPPLIER PRODUCT ID	ENZ LIST CODE	ACC SIC CODE	
MP30101	ENZA30	EC001	

Bed Cradle			Simple
		SPECIFICATIONS	
		Blanket cradle for bed 320 overall width 500mm overall length 600mm overall height	
SUPPLIER/BRAND		MAX USER WEIGHT	
Cubro/Viking		N/A	
SUPPLIER PRODUCT ID	ENZ LIST CODE	ACC SIC CODE	
283	ENZA29	EC010	

Bed Lever			Simple
		SPECIFICATIONS	
		Bed Lever flat bottom with anti-entrapment bar, cord and cleat wood base 550mm Loop height 800mm Board length 290mm Width of board	
SUPPLIER/BRAND		MAX USER WEIGHT	
Tastech Services Ltd		150kg	
SUPPLIER PRODUCT ID	ENZ LIST CODE	ACC SIC CODE	
BLF3	ENZA292	EC023	

ACC Simple List Equipment

Bedroom

Overbed pole			Simple
		SPECIFICATIONS	
		Freestanding over bed pole 1785mm height 885mm min handle height	
SUPPLIER/BRAND		MAX USER WEIGHT	
Superquip		120kg	
SUPPLIER PRODUCT ID	ENZ LIST CODE	ACC SIC CODE	
070	ENZA117	EC041	

Overbed/chair Table			Simple
		SPECIFICATIONS	
		Tilt Top U Base 450x750mm top size 600-960mm adjustable height	
SUPPLIER/BRAND		MAX USER WEIGHT	
Cubro/Viking		N/A	
SUPPLIER PRODUCT ID	ENZ LIST CODE	ACC SIC CODE	
575	ENZA101	EC050	

ACC Simple List Equipment

Bedroom

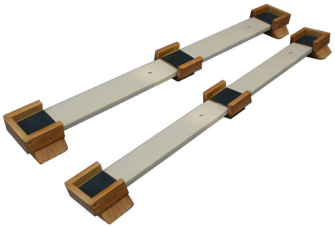
Bed Raiser			Simple
		SPECIFICATIONS	
		Double bed raiser Set of 2 Suits all sizes of double beds that have legs or glides or castor wheels 90x90mm foot pad 150-1700mm adjustable width Standard double to Superking size	
SUPPLIER/BRAND		MAX USER WEIGHT	
Multifit Hospital Supplies		380kg	
SUPPLIER PRODUCT ID	ENZ LIST CODE	HEIGHT	ACC SIC CODE
MF2/4-50/2	ENZA128	50mm	EC062
MF2/4-75/2	ENZA129	75mm	EC063
MF2/4-100/2	ENZA125	100mm	EC060
MF2/4-150/2	ENZA130	150mm	EC064

Bed Raiser			Simple
		SPECIFICATIONS	
		Single Bed troughs Set of 2 Suits single beds that have legs or glides or castor wheels 90x90mm foot pad 815-1100mm adjustable width	
SUPPLIER/BRAND		MAX USER WEIGHT	
Multifit Hospital Supplies		380kg	
SUPPLIER PRODUCT ID	ENZ LIST CODE	HEIGHT	ACC SIC CODE
MF2/2-50/2	ENZA120	50mm	EC065
MF2/2-75/2	ENZA121	75mm	EC066
MF2/2-100/2	ENZA119	100mm	EC061
MF2/2-150/2	ENZA122	150mm	EC067

ACC Simple List Equipment

Kitchen & Living

Perching Stool with Arms			Simple
		SPECIFICATIONS	
		Adjustable height With Arms and Back 320mm seat width 885mm min handle height	
SUPPLIER/BRAND		MAX USER WEIGHT	
Allied Medical Ltd		113kg	
SUPPLIER PRODUCT ID	ENZ LIST CODE	ACC SIC CODE	
AML3035	ENZA57	EK040	

Perching Stool without Arms			Simple
		SPECIFICATIONS	
		Adjustable height Without Arms and back 510x420mm Seat 560-700mm Adjustable height	
SUPPLIER/BRAND		MAX USER WEIGHT	
Allied Medical Ltd		125kg	
SUPPLIER PRODUCT ID	ENZ LIST CODE	ACC SIC CODE	
MP30304	ENZA44	EK041	

Perching Stool without Arms			Simple
		SPECIFICATIONS	
		Adjustable height Without arms, with back 330x310 Seat 550mmx700mm Adjustable height	
SUPPLIER/BRAND		MAX USER WEIGHT	
Cubro/Viking		120kg	
SUPPLIER PRODUCT ID	ENZ LIST CODE	ACC SIC CODE	
746	ENZA96	EK043	

ACC Simple List Equipment

Kitchen & Living

Utility Chair			Simple
		SPECIFICATIONS	
		Rehab chair Multi purpose 430 - 580mm adjustable height 440mm width between arms 430mm seat width 440mm seat depth	
SUPPLIER/BRAND		MAX USER WEIGHT	
Cubro/Viking		200kg	
SUPPLIER PRODUCT ID	ENZ LIST CODE	ACC SIC CODE	
609S	ENZA116	EK060	

Utility Chair			Simple
		SPECIFICATIONS	
		Hilite chair Multit purpose 550 - 400mm adjustable height 520mm width between arms 520mm seat width 480-520 seat depth adjustable	
SUPPLIER/BRAND		MAX USER WEIGHT	
Cubro/Viking		200kg	
SUPPLIER PRODUCT ID	ENZ LIST CODE	ACC SIC CODE	
610S	ENZA171	EK061	

ACC Simple List Equipment

Kitchen & Living

Kitchen Trolley			Simple
		SPECIFICATIONS	
		Kitchen Trolley with handle 430mm width 430mm depth 870mm height	
SUPPLIER/BRAND		MAX WEIGHT - ON TRAY	
Tastech Services Ltd		30kg	
SUPPLIER PRODUCT ID	ENZ LIST CODE	ACC SIC CODE	
RT1H	ENZA84	EK031	

Kitchen Trolley			Simple
		SPECIFICATIONS	
		Kitchen Trolley Adjustable height 430mm width 430mm depth 870mm height	
SUPPLIER/BRAND		MAX WEIGHT - ON TRAY	
Superquip Ltd		30kg	
SUPPLIER PRODUCT ID	ENZ LIST CODE	ACC SIC CODE	
061A	ENZA271	EK032	

Kitchen Trolley			Simple
		SPECIFICATIONS	
		Kitchen Trolley Adjustable Height 465mm width 490mm length 785-935mm adjustable height	
SUPPLIER/BRAND		MAX WEIGHT - ON TRAY	
Cubro/Chevron		10kg	
SUPPLIER PRODUCT ID	ENZ LIST CODE	ACC SIC CODE	
290	ENZA88	EK030	

ACC Simple List Equipment

Kitchen & Living

Can Opener			Simple
		SPECIFICATIONS	
		Open all electric can opener	
SUPPLIER/BRAND		MAX USER WEIGHT	
Noel Leeming/Sunbeam		N/A	
SUPPLIER PRODUCT ID	ENZ LIST CODE	ACC SIC CODE	
CA2800	ENZA1	EK020	

Jar Opener			Simple
		SPECIFICATIONS	
		Good Grips Twisting Jar Opener 177mm Length	
SUPPLIER/BRAND		MAX USER WEIGHT	
Allied Medical Ltd		N/A	
SUPPLIER PRODUCT ID	ENZ LIST CODE	ACC SIC CODE	
GG11332200	ENZA11126	EK021	

Cutlery			Simple
		SPECIFICATIONS	
		Supergrip bendable set of 4	
SUPPLIER/BRAND		MAX USER WEIGHT	
AT Therapy Ltd		N/A	
SUPPLIER PRODUCT ID	ENZ LIST CODE	ACC SIC CODE	
PAT-A703209	ENZA38	EK023	

ACC Simple List Equipment

Kitchen & Living

Kettle Tipper			Simple
		SPECIFICATIONS	
		Kettle Tipper Cordless	
SUPPLIER/BRAND		MAX USER WEIGHT	
At Therapy Ltd/Homecraft		N/A	
SUPPLIER PRODUCT ID	ENZ LIST CODE	ACC SIC CODE	
	ENZA46	EK026	

Preparation Board			Simple
		SPECIFICATIONS	
		Spreading Board plastic 256x181mm	
SUPPLIER/BRAND		MAX USER WEIGHT	
At Therapy Ltd/Homecraft		N/A	
SUPPLIER PRODUCT ID	ENZ LIST CODE	ACC SIC CODE	
PAT-AA5284	ENZA283	EK070	

Preparation Board			Simple
		SPECIFICATIONS	
		Vegetable spike board 320x300x100mm	
SUPPLIER/BRAND		MAX USER WEIGHT	
Cubro/Etac		N/A	
SUPPLIER PRODUCT ID	ENZ LIST CODE	ACC SIC CODE	
5460	ENZA291	EK071	

ACC Simple List Equipment

Kitchen & Living

Preparation Board			Simple
		SPECIFICATIONS	
		Vegetable spike board Small Plastic 140x140x100mm	
SUPPLIER/BRAND		MAX USER WEIGHT	
TasTech Services Ltd		N/A	
SUPPLIER PRODUCT ID	ENZ LIST CODE	ACC SIC CODE	
VH1	ENZA284	EK072	

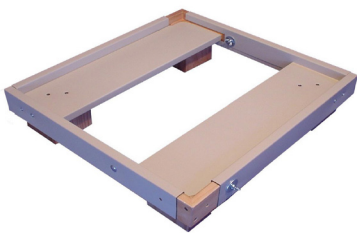
Chair Platform Raiser				Simple
		SPECIFICATIONS		
		Standard Chair Suits most square shape lounge chairs 438-816mm adjustable width 528-873mm adjustable length		
SUPPLIER/BRAND		MAX USER WEIGHT		
Multifit Hospital Supplies		380kg over 4 feet		
SUPPLIER PRODUCT ID	ENZ LIST CODE	HEIGHT	ACC SIC CODE	
MF 1/1-50	ENZA108	50mm	EK003	
MF 1/1-75	ENZA109	75mm	EK004	
MF 1/1-100	ENZA106	100mm	EK001	
MF 1/1-150	ENZA107	150mm	EK002	

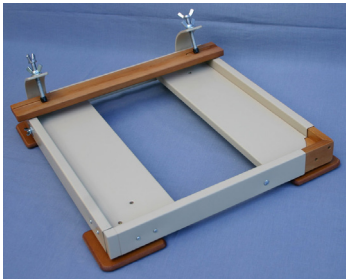
Chair Platform Raiser				Simple
		SPECIFICATIONS		
		Lazy Boy Style Suits LazyBoy style chair which have wooden runners that extend past the rear of the chair base 485-710mm adjustable width 530-885mm adjustable length		
SUPPLIER/BRAND		MAX USER WEIGHT		
Multifit Hospital Supplies		380kg over 4 feet		
SUPPLIER PRODUCT ID	ENZ LIST CODE	HEIGHT	ACC SIC CODE	
MF 1/3-50	ENZA140	50mm	EK007	
MF 1/3-75	ENZA141	75mm	EK008	
MF 1/3-100	ENZA138	100mm	EK005	
MF 1/3-150	ENZA139	150mm	EK006	

ACC Simple List Equipment

Kitchen & Living

Raiser				Simple
		SPECIFICATIONS		
		Elephant Feet set of 4		
SUPPLIER/BRAND		MAX USER WEIGHT		
Cubro/Derby		100kg per foot		
SUPPLIER PRODUCT ID	ENZ LIST CODE	HEIGHT	ACC SIC CODE	
181/4	ENZA40	90mm	EK013	
182/4	ENZA45	140mm	EK012	

Chair/Bed Blocks				Simple
		SPECIFICATIONS		
		Chair/Bed Blocks wooden (each)		
SUPPLIER/BRAND		MAX USER WEIGHT		
Multifit Hospital Supplies		100kg per foot		
SUPPLIER PRODUCT ID	ENZ LIST CODE	HEIGHT	ACC SIC CODE	
MF 0/1	ENZA35	50mm	EK010	
MF 0/2	ENZA36	75mm	EK011	
MF 0/3	ENZA34	100mm	EK009	
MF 0/4	ENZA37	150mm	EK014	

ACC Simple List Equipment

Manual Handling

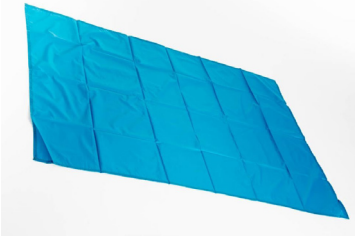
Slide Sheets			Simple
		SPECIFICATIONS	
		Slide Sheet 1metre x 1.5metres	
SUPPLIER/BRAND		MAX USER WEIGHT	
Multifit Hospital Supplies		N/A	
SUPPLIER PRODUCT ID	ENZ LIST CODE	ACC SIC CODE	
MF SS_AMS 1	ENZA26	EH002	

Slide Sheets			Simple
		SPECIFICATIONS	
		Slide Sheet 1100x1500mm	
SUPPLIER/BRAND		MAX USER WEIGHT	
Cubro/Softech		N/A	
SUPPLIER PRODUCT ID	ENZ LIST CODE	ACC SIC CODE	
195	ENZA27	EH001	

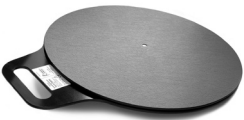
Turntable			Simple
		SPECIFICATIONS	
		RoMedic Turntable 38cm 380mm Diameter	
SUPPLIER/BRAND		MAX USER WEIGHT	
USL Medical/RoMedic		135kg	
SUPPLIER PRODUCT ID	ENZ LIST CODE	ACC SIC CODE	
5085	ENZA97	EH011	

ACC Simple List Equipment

Manual Handling

Transfer Belt				Simple
		SPECIFICATIONS		
		Romedic FlexiBelt Hug Waist Measurement Small- 60-100cm Medium - 70-120cm Large - 100cm-160cm		
SUPPLIER/BRAND		MAX USER WEIGHT		
USL Medical/RoMedic		170kg		
SUPPLIER PRODUCT ID	ENZ LIST CODE	HEIGHT	ACC SIC CODE	
6073	ENZA81	Small	EH012	
6074	ENZA103	Medium	EH013	
6075	ENZA90	Large	EH014	

Transfer Board				Simple
		SPECIFICATIONS		
		Plastic construction Curved board 660mm long 200mm wide		
SUPPLIER/BRAND		MAX USER WEIGHT		
TasTech Services Ltd		110kg		
SUPPLIER PRODUCT ID	ENZ LIST CODE	ACC SIC CODE		
TBP2	ENZA60	EM021		
SIMILAR				
SUPPLIER/BRAND	MAX USER WEIGHT	SPECIFICATIONS		
Keyport	130kg	755mm long 210mm wide		
SUPPLIER PRODUCT ID	ENZ LIST CODE			
157	ENZA2			

ACC Simple List Equipment

Office

Copy Holder			Simple
		SPECIFICATIONS	
		Gooduse Microdesk 560mm wide 310mm deep	
SUPPLIER/BRAND		MAX USER WEIGHT	
Bytes & Pieces Ltd		N/A	
SUPPLIER PRODUCT ID	ENZ LIST CODE	ACC SIC CODE	
GU-01	ENZA76	EF030	

Copy Holder			Simple
		SPECIFICATIONS	
		3M Document Holder 450.7x270.9x100.1mm	
SUPPLIER/BRAND		MAX USER WEIGHT	
Bytes & Pieces Ltd		N/A	
SUPPLIER PRODUCT ID	ENZ LIST CODE	ACC SIC CODE	
3MDH640a	ENZA83	EF034	

Whiteboard			Simple
		SPECIFICATIONS	
		Whiteboard with pack of 4 markers 400x600mm	
SUPPLIER/BRAND		MAX USER WEIGHT	
Bytes & Pieces Ltd		N/A	
SUPPLIER PRODUCT ID	ENZ LIST CODE	ACC SIC CODE	
WB-LAC4b	ENZA56	EF031	

ACC Simple List Equipment

Office

Foot Stool			Simple
		SPECIFICATIONS	
		Fellowes Footrest 455 x 338 x 97mm	
SUPPLIER/BRAND		MAX USER WEIGHT	
Bytes & Pieces Ltd		N/A	
SUPPLIER PRODUCT ID	ENZ LIST CODE	ACC SIC CODE	
C236295b	ENZA48	EF107	

Leg Rest			Simple
		SPECIFICATIONS	
		Legrest adjustable 400-550mm Adjustable height	
SUPPLIER/BRAND		MAX USER WEIGHT	
Cubro/Viking		100kg	
SUPPLIER PRODUCT ID	ENZ LIST CODE	ACC SIC CODE	
60L-SLATE	ENZA113	EF108	

Foot Stool			Simple
		SPECIFICATIONS	
		Footstool Fluteline Large 450 x 350mm	
SUPPLIER/BRAND		MAX USER WEIGHT	
Bytes & Pieces Ltd		N/A	
SUPPLIER PRODUCT ID	ENZ LIST CODE	ACC SIC CODE	
F-Footstool	ENZA58	EF109	

ACC Simple List Equipment

Office

Office Chair			Simple
		SPECIFICATIONS	
		Spectrum 2 Hi back No arms Black Back 460mm Seat depth 480mm Seat width 470mm	
SUPPLIER/BRAND		MAX USER WEIGHT	
Bytes & Pieces Ltd		140kg	
SUPPLIER PRODUCT ID	ENZ LIST CODE	ACC SIC CODE	
Spec2BK	ENZA170	EF111	

Office Chair			Simple
		SPECIFICATIONS	
		Spectrum 3 Hi back No arms Navy Back 460mm Seat depth 480mm Seat width 470mm	
SUPPLIER/BRAND		MAX USER WEIGHT	
Bytes & Pieces Ltd		140kg	
SUPPLIER PRODUCT ID	ENZ LIST CODE	ACC SIC CODE	
E-Spec3N	ENZA173	EF112	

Office Chair			Simple
		SPECIFICATIONS	
		Spectrum 2 Hi back Height adjustable arms Navy Back 460mm Seat depth 480mm Seat width 470mm	
SUPPLIER/BRAND		MAX USER WEIGHT	
Bytes & Pieces Ltd		140kg	
SUPPLIER PRODUCT ID	ENZ LIST CODE	ACC SIC CODE	
E-Spec2HA	ENZA174	EF113	

ACC Simple List Equipment

Office

Office Chair			Simple
		SPECIFICATIONS	
		Spectrum 3 Hi back Height adjustable arms Black Back 460mm Seat depth 480mm Seat width 470mm	
SUPPLIER/BRAND		MAX USER WEIGHT	
Bytes & Pieces Ltd		140kg	
SUPPLIER PRODUCT ID	ENZ LIST CODE	ACC SIC CODE	
Spec3HA	ENZA178	EF114	

Office Seat			Simple
		SPECIFICATIONS	
		Bambach saddle seat 570-750mm adjustable seat height	
SUPPLIER/BRAND		MAX USER WEIGHT	
Bytes & Pieces Ltd		120kg	
SUPPLIER PRODUCT ID	ENZ LIST CODE	ACC SIC CODE	
B-Bamach	ENZA181	EF116	

Office Seat			Simple
		SPECIFICATIONS	
		Buro knee Chair Black 430x250mm knee rest 430x340mm seat 530-650mm adjustable seat height	
SUPPLIER/BRAND		MAX USER WEIGHT	
Bytes & Pieces Ltd		130kg	
SUPPLIER PRODUCT ID	ENZ LIST CODE	ACC SIC CODE	
B-Knee	ENZA147	EF117	

ACC Simple List Equipment

Office

Office Seat			Simple
		SPECIFICATIONS	
		Posturite Stool No arms Tilt seat 370mm seat depth 410mm seat height 620-70mm adjustable seat height	
SUPPLIER/BRAND		MAX USER WEIGHT	
Bytes & Pieces Ltd		120kg	
SUPPLIER PRODUCT ID	ENZ LIST CODE	ACC SIC CODE	
B-POS270	ENZA136	EF118	

Computer			Simple
		SPECIFICATIONS	
		Microsoft Basic Mouse Wired Optical	
SUPPLIER/BRAND		MAX USER WEIGHT	
Bytes & Pieces Ltd		N/A	
SUPPLIER PRODUCT ID	ENZ LIST CODE	ACC SIC CODE	
1041777	ENZA20	EG010	

Computer			Simple
		SPECIFICATIONS	
		Logitech K120 USB Wired	
SUPPLIER/BRAND		MAX USER WEIGHT	
Bytes & Pieces Ltd		N/A	
SUPPLIER PRODUCT ID	ENZ LIST CODE	ACC SIC CODE	
LOGITECH K120	ENZA22	EG024	

ACC Simple List Equipment

Office

Computer			Simple
		SPECIFICATIONS	
		Microsoft Ergonomic Keyboard Wired	
SUPPLIER/BRAND		MAX USER WEIGHT	
Bytes & Pieces Ltd		N/A	
SUPPLIER PRODUCT ID	ENZ LIST CODE	ACC SIC CODE	
N/A	ENZA61	EG025	

Monitor Stand			Simple
		SPECIFICATIONS	
		Fellowes Premium Monitor Stand 334x340mm Adjustable to 5 heights 64-165mm	
SUPPLIER/BRAND		MAX USER WEIGHT	
Bytes & Pieces Ltd		N/A	
SUPPLIER PRODUCT ID	ENZ LIST CODE	ACC SIC CODE	
C-235001b	ENZA49	EG031	

Laptop Raiser			Simple
		SPECIFICATIONS	
		Fellowes Laptop Raiser 165x384x289mm	
SUPPLIER/BRAND		MAX USER WEIGHT	
Bytes & Pieces Ltd		N/A	
SUPPLIER PRODUCT ID	ENZ LIST CODE	ACC SIC CODE	
C-236840	ENZA41	EG041	

ACC Simple List Equipment

Office

Ergorest			Simple
		SPECIFICATIONS	
		Ergorest Forearm Support 235mm max operating span 75mm height adjustment 15-43mm desk thickness	
SUPPLIER/BRAND		MAX LOAD	
Bytes & Pieces Ltd		12kg	
SUPPLIER PRODUCT ID	ENZ LIST CODE	ACC SIC CODE	
SY-Ergorests	ENZA92	EG050	

Wrist Rest			Simple
		SPECIFICATIONS	
		Keyboard supergel wrist rest 460x60.5x20mm	
SUPPLIER/BRAND		MAX USER WEIGHT	
Bytes & Pieces Ltd		N/A	
SUPPLIER PRODUCT ID	ENZ LIST CODE	ACC SIC CODE	
L-MP128	ENZA23	EG051	

Wrist Rest			Simple
		SPECIFICATIONS	
		Fellowes Flex rest 2.54x12.38x8.73cm	
SUPPLIER/BRAND		MAX USER WEIGHT	
Bytes & Pieces Ltd		N/A	
SUPPLIER PRODUCT ID	ENZ LIST CODE	ACC SIC CODE	
C-236439b	ENZA280	EG052	

ACC Simple List Equipment

Shower & Bath

Suction Rails			Simple
		SPECIFICATIONS	
		Roth Rail Extendable with safety indicator 560-685mm max length adjustment	
SUPPLIER/BRAND		MAX USER WEIGHT	
Medix 21/Roth		85kg	
SUPPLIER PRODUCT ID	ENZ LIST CODE	ACC SIC CODE	
1400222S	ENZA124	EA010	

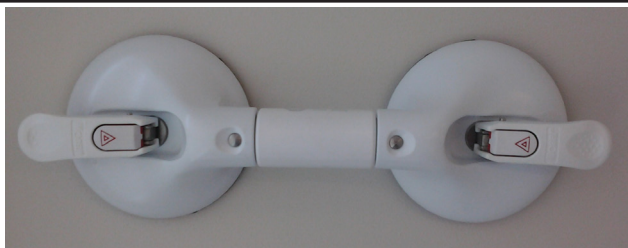
Suction Rails			Simple
		SPECIFICATIONS	
		Roth Rail Short 110mm length	
SUPPLIER/BRAND		MAX USER WEIGHT	
Medix 21/Roth		85kg	
SUPPLIER PRODUCT ID	ENZ LIST CODE	ACC SIC CODE	
1400220S	ENZA85	EA011	

Bath Board			Simple
		SPECIFICATIONS	
		Bath Board - Moulded Plastic 710x290x25mm 25mm max height 480-700mm pillar span	
SUPPLIER/BRAND		MAX USER WEIGHT	
Cubro/Cosby		190kg	
SUPPLIER PRODUCT ID	ENZ LIST CODE	ACC SIC CODE	
243	ENZA288	EB001	

ACC Simple List Equipment

Shower & Bath

Bath Board			Simple
		SPECIFICATIONS	
		Bath Board - Moulded Plastic 710x305x68mm 68mm max height 480-630mm pillar span	
SUPPLIER/BRAND		MAX USER WEIGHT	
Cubro/Derby		190kg	
SUPPLIER PRODUCT ID	ENZ LIST CODE	ACC SIC CODE	
257	ENZA77	EB002	

Transfer Bench			Simple
		SPECIFICATIONS	
		Transfer Bench 825-940mm adjustable height 380-490mm bath clearance 845mm width 500mm depth	
SUPPLIER/BRAND		MAX USER WEIGHT	
Cubro/Oakwood		130kg	
SUPPLIER PRODUCT ID	ENZ LIST CODE	ACC SIC CODE	
256	ENZA93	EB020	

Transfer Bench			Simple
		SPECIFICATIONS	
		Transfer Bench Padded 795-910mm adjustable height 350-460mm bath clearance	
SUPPLIER/BRAND		MAX USER WEIGHT	
Cubro/Oakwood		130kg	
SUPPLIER PRODUCT ID	ENZ LIST CODE	ACC SIC CODE	
241	ENZA145	EB113	

ACC Simple List Equipment

Shower & Bath

Shower Chair		Simple
	SPECIFICATIONS	
	Shower chair with arms 490mm width between arms 490-640mm adjustable height	
SUPPLIER/BRAND		MAX USER WEIGHT
Goldfern Mobility		110kg
SUPPLIER PRODUCT ID	ENZ LIST CODE	ACC SIC CODE
GM-HMP-792LA	ENZA297	EB045

Shower Stool		Simple
	SPECIFICATIONS	
	Shower stool without arms 490-610mm adjustable height 285x380mm seat size	
SUPPLIER/BRAND		MAX USER WEIGHT
Goldfern Mobility		120kg
SUPPLIER PRODUCT ID	ENZ LIST CODE	ACC SIC CODE
GM-HMP-792	ENZA43	EB046

ACC Simple List Equipment

Shower & Bath

Shower Stool			Simple
		SPECIFICATIONS	
		Shower stool with arms 470mm width between arms 490-610mm adjustable height	
SUPPLIER/BRAND		MAX USER WEIGHT	
Goldfern Mobility		170kg	
SUPPLIER PRODUCT ID	ENZ LIST CODE	ACC SIC CODE	
GM-HMP-792A	ENZA296	EB044	

Shower Stool			Simple
		SPECIFICATIONS	
		Shower stool with arms - Heavy duty Height adjustable 440-600mm height adjustable 440x360mm seat size 480mm width between arms	
SUPPLIER/BRAND		MAX USER WEIGHT	
Tubular Equipment		200kg	
SUPPLIER PRODUCT ID	ENZ LIST CODE	ACC SIC CODE	
SSHD61	ENZA114	EB043	

ACC Simple List Equipment

Shower & Bath

Swivel bather				Simple
		SPECIFICATIONS		
		Swivel bath seat See below for height options 470mm width between arms 700-855mm adjustable base width 420mm back height		
SUPPLIER/BRAND		MAX USER WEIGHT		
Cubro/Oakwood		120kg		
SUPPLIER PRODUCT ID	ENZ LIST CODE	HEIGHT	ACC SIC CODE	
508	ENZA144	Swivel Bather	EB050	
508/HA50	ENZA168	Swivel Bather with 50mm height adaptor	EB051	
508/HA100	ENZA169	Swivel Bather with 100mm height adaptor	EB052	

Shower Attachment				Simple
		SPECIFICATIONS		
		Handheld bath & shower set 150cm Hose length		
SUPPLIER/BRAND		MAX USER WEIGHT		
Cubro/Oakwood		N/A		
SUPPLIER PRODUCT ID	ENZ LIST CODE	ACC SIC CODE		
190	ENZA286	EB030		

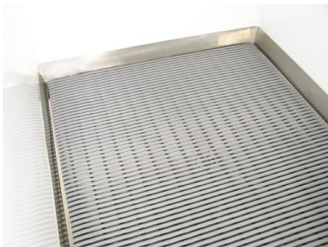
Shower Mat				Simple
		SPECIFICATIONS		
		Shower Matting 900x1000mm		
SUPPLIER/BRAND		MAX USER WEIGHT		
Cubro/Hull		N/A		
SUPPLIER PRODUCT ID	ENZ LIST CODE	ACC SIC CODE		
224	ENZA289	EB061		

ACC Simple List Equipment

Shower & Bath

Step		Simple	
		SPECIFICATIONS	
		Bathroom two step 100 or 150 mm step height	
SUPPLIER/BRAND		MAX USER WEIGHT	
Cubro/Ashby		190kg	
SUPPLIER PRODUCT ID	ENZ LIST CODE	ACC SIC CODE	
124	ENZA294	EB070	

Long handled sponge		Simple	
		SPECIFICATIONS	
		Long handled Sponge 550mm length	
SUPPLIER/BRAND		MAX USER WEIGHT	
Cubro		190kg	
SUPPLIER PRODUCT ID	ENZ LIST CODE	ACC SIC CODE	
1088093	ENZA277	EB080	

ACC Simple List Equipment

Shower & Bath

Shower Commode			Simple
		SPECIFICATIONS	
		Shower commode attendant propelled Frame only 490mm width between arms Seat not included please select accessories below	
SUPPLIER/BRAND		MAX USER WEIGHT	
Cubro/Juvo Viking		200kg	
SUPPLIER PRODUCT ID	ENZ LIST CODE	ACC SIC CODE	
2346U	ENZA205	EB126	
ACCESSORIES			
DESCRIPTION	ENZ LIST CODE	SUPPLIER PRODUCT ID	ACC SIC CODE
Closed Seat	ENZA79	75PC/75PR-FITTED	EB107
Open Seat	ENZA80	75PO/75PR-FITTED	EB108
Bedpan & carrier	ENZA52	2359/75P	EB105
Bowl w/ lid & Pan carrier	ENZA53	2359/325	EB106

Shower Commode			Simple
		SPECIFICATIONS	
		Shower commode self propelled Frame only 465mm width between arms Seat not included please select accessories below	
SUPPLIER/BRAND		MAX USER WEIGHT	
Cubro/Juvo Viking		200kg	
SUPPLIER PRODUCT ID	ENZ LIST CODE	ACC SIC CODE	
2348U	ENZA211	EB127	
ACCESSORIES			
DESCRIPTION	ENZ LIST CODE	SUPPLIER PRODUCT ID	ACC SIC CODE
Closed Seat	ENZA79	75PC/75PR-FITTED	EB107
Open Seat	ENZA80	75PO/75PR-FITTED	EB108
Bedpan & carrier	ENZA52	2359/75P	EB105
Bowl w/ lid & Pan carrier	ENZA53	2359/325	EB106

ACC Simple List Equipment



Toileting

Bed Pan			Simple
		SPECIFICATIONS	
		Bed pan Autoclavable 135°C.	
SUPPLIER/BRAND		MAX USER WEIGHT	
Cubro/Plasbro		N/A	
SUPPLIER PRODUCT ID	ENZ LIST CODE	ACC SIC CODE	
211	ENZA19	ET001	

Bedside commode			Simple
		SPECIFICATIONS	
		Bedside commode 480-600mm adjustable seat height 440mm seat width 440mm seat depth	
SUPPLIER/BRAND		MAX USER WEIGHT	
Cubro/Viking		120kg	
SUPPLIER PRODUCT ID	ENZ LIST CODE	ACC SIC CODE	
565	ENZA293	ET011	

ACC Simple List Equipment

Toileting

3 n 1 Commode			Simple
		SPECIFICATIONS	
		3 in 1 Commode 640mm overall width 450mm overall depth 420-560 Adj floor to seat height	
SUPPLIER/BRAND		MAX USER WEIGHT	
Allied Medical/Maxhealth			
SUPPLIER PRODUCT ID	ENZ LIST CODE	ACC SIC CODE	
AML20505	ENZA1809	ET051	
Toilet Surround			Simple
		SPECIFICATIONS	
		Freestanding toilet frame 675-775mm adjustable height 440-640mm adjustable width	
SUPPLIER/BRAND		MAX USER WEIGHT	
Goldfern Mobility		120kg	
SUPPLIER PRODUCT ID	ENZ LIST CODE	ACC SIC CODE	
GM-HMP-8109	ENZA290	ET014	
ACCESSORIES			
DESCRIPTION	ENZ LIST CODE	SUPPLIER PRODUCT ID	ACC SIC CODE
Suction Feet	ENZA264	GMP-HMP-8109TIP-S	ET016

ACC Simple List Equipment

Toileting

Toilet Surround			Simple
		SPECIFICATIONS	
		Freestanding toilet frame Heavy duty 440-640mm adjustable width 675-775mm adjustable height	
SUPPLIER/BRAND		MAX USER WEIGHT	
Goldfern Mobility		200kg	
SUPPLIER PRODUCT ID	ENZ LIST CODE	ACC SIC CODE	
GM-HMP-8109S	ENZA59	ET015	
ACCESSORIES			
DESCRIPTION	ENZ LIST CODE	SUPPLIER PRODUCT ID	ACC SIC CODE
Suction Feet	ENZA16	GMP-HMP-8109TIP-S	ET016

Toilet Frame			Simple
		SPECIFICATIONS	
		Over-toilet frame Supplied with splash guard 480-620mm adjustable height 445mm between arm width	
SUPPLIER/BRAND		MAX USER WEIGHT	
Cubro/Viking		150kg	
SUPPLIER PRODUCT ID	ENZ LIST CODE	ACC SIC CODE	
390	ENZA287	ET030	

Toilet Frame			Simple
		SPECIFICATIONS	
		Over toilet frame heavy duty extra wide seat fixed height 570mm seat height 600mm between arms	
SUPPLIER/BRAND		MAX USER WEIGHT	
Cubro/Viking		300kg	
SUPPLIER PRODUCT ID	ENZ LIST CODE	ACC SIC CODE	
398	ENZA295	ET052	

ACC Simple List Equipment

Toileting

Toilet Seat				Simple
		SPECIFICATIONS		
		Raised toilet seat 207x266mm inside aperture		
SUPPLIER/BRAND		MAX USER WEIGHT		
AT Therapy/Savanah		190kg		
SUPPLIER PRODUCT ID	ENZ LIST CODE	HEIGHT	ACC SIC CODE	
PAT-AA2112	ENZA32	50mm	ET045	
PAT-AA2114Y	ENZA33	100mm	ET044	

Toilet Seat				Simple
		SPECIFICATIONS		
		Raised toilet seat 215x260mm inside aperture		
SUPPLIER/BRAND		MAX USER WEIGHT		
Etac/Cubro		150kg		
SUPPLIER PRODUCT ID	ENZ LIST CODE	HEIGHT	ACC SIC CODE	
5450	ENZA3453	60mm	ET043	
5451	ENZA3454	100mm	ET042	

Bottom Wiper			Simple
		SPECIFICATIONS	
		Toileting bottom wiper 265mm length.	
SUPPLIER/BRAND		MAX USER WEIGHT	
AT Therapy/Homecare		N/A	
SUPPLIER PRODUCT ID	ENZ LIST CODE	ACC SIC CODE	
PAT-AA2650	ENZA285	ET021	

ACC Simple List Equipment

Wheelchairs & Seating

Cushion				Simple
		SPECIFICATIONS		
		Komfit Cushion		
SUPPLIER/BRAND		MAX USER WEIGHT		
Permobil/Komfit		95kg		
SUPPLIER PRODUCT ID	ENZ LIST CODE	SIZE	ACC SIC CODE	
CU502	ENZA74	16x16	EK109	
CU505	ENZA75	18x18	EK111	

Wheelchair - Transit				Simple
		SPECIFICATIONS		
		Action 1R Folding Frame Transit wheelchair 12" Transit Wheels 80 degree removeable swing away Flip up footplate Push brakes		
SUPPLIER/BRAND		MAX USER WEIGHT		
Invacare/Action 1R		125kg		
SUPPLIER PRODUCT ID	ENZ LIST CODE	SIZE	ACC SIC CODE	
PKG-DK1640990	ENZA133	16x16.75	EM073	
PKG-DK1640992	ENZA134	18x16.75	EM073	
ACCESSORIES - Elevating legrests				
DESCRIPTION	ENZ LIST CODE	SUPPLIER PRODUCT ID	ACC SIC CODE	
Right hand side 16"	ENZA68	1562037	EM086	
Left hand side 16"	ENZA69	1562008	EM087	
Right hand side 18"	ENZA70	1562039	EM088	
Left hand side 18"	ENZA71	1562038	EM089	

ACC Simple List Equipment

Wheelchairs & Seating

Wheelchair - Self Propelling				Simple
		SPECIFICATIONS		
		Action 1R Folding Frame Self propelling wheelchair 24" Rear wheels 80 degree removeable swing away Flip up footplate Push brakes		
SUPPLIER/BRAND		MAX USER WEIGHT		
Invacare/Action 1R		125kg		
SUPPLIER PRODUCT ID	ENZ LIST CODE	SIZE	ACC SIC CODE	
PKG-DK1640966	ENZA131	16x16.75	EM072	
PKG-DK1640968	ENZA132	18x16.75	EM072	
ACCESSORIES - Elevating legrests				
DESCRIPTION	ENZ LIST CODE	SUPPLIER PRODUCT ID	ACC SIC CODE	
Right hand side 16"	ENZA68	1562037	EM086	
Left hand side 16"	ENZA69	1562008	EM087	
Right hand side 18"	ENZA70	1562039	EM088	
Left hand side 18"	ENZA71	1562038	EM089	

Ramps				Simple
		SPECIFICATIONS		
		Aluminium ramp with non-skid surface		
SUPPLIER/BRAND		MAX USER WEIGHT		
Cubro/EuroRamps		287kg		
SUPPLIER PRODUCT ID	ENZ LIST CODE	SIZE	ACC SIC CODE	
547	ENZA91	25mm H x 125mm L x 850mm W	EM109	
548	ENZA98	50mm H x 250mm L x 850mm	EM110	
549	ENZA111	75mm H x 375mm L x 850mm W	EM111	

ACC Simple List Equipment

Daily Living Aids

Dressing & Grooming			Simple
		SPECIFICATIONS	
		Sock aid Standard	
SUPPLIER/BRAND		MAX USER WEIGHT	
Allied Medical/Parsons		N/A	
SUPPLIER PRODUCT ID	ENZ LIST CODE	ACC SIC CODE	
PA16D005	ENZA18	EC070	

Dressing & Grooming			Simple
		SPECIFICATIONS	
		Shoe horn - Metal 24"	
SUPPLIER/BRAND		MAX USER WEIGHT	
Mobility Supplies NZ		N/A	
SUPPLIER PRODUCT ID	ENZ LIST CODE	ACC SIC CODE	
1028S	ENZA279	EO002	

Reacher				Simple
		SPECIFICATIONS		
		Reacher Magnetic tip		
SUPPLIER/BRAND		MAX USER WEIGHT		
Cubro/Hull		N/A		
SUPPLIER PRODUCT ID	ENZ LIST CODE	SIZE	ACC SIC CODE	
144	ENZA281	25.6" (600mm)	EK050	
146	ENZA282	32.5" (700mm)	EK051	

ACC Simple List Equipment

Daily Living Aids

Seat & Back Cushion			Simple
		SPECIFICATIONS	
		Obusforme contoured seat cushion 40x45cm	
SUPPLIER/BRAND		MAX USER WEIGHT	
Amtech Medical Aid		N/A	
SUPPLIER PRODUCT ID	ENZ LIST CODE	ACC SIC CODE	
SU442	ENZA55	EK104	

Seat & Back Cushion			Simple
		SPECIFICATIONS	
		BackFriend back & seat cushion	
SUPPLIER/BRAND		MAX USER WEIGHT	
Ergogo		N/A	
SUPPLIER PRODUCT ID	ENZ LIST CODE	SIZE	ACC SIC CODE
BF1/1	ENZA104	Standard	EK105

Seat & Back Cushion			Simple
		SPECIFICATIONS	
		BackFriend back only	
SUPPLIER/BRAND		MAX USER WEIGHT	
Ergogo		N/A	
SUPPLIER PRODUCT ID	ENZ LIST CODE	SIZE	ACC SIC CODE
BF3	ENZA64	Standard	EK107

ACC Simple List Equipment

Daily Living Aids

Seat & Back Cushions			Simple
		SPECIFICATIONS	
		Obusforme low back rest 53x45cm	
SUPPLIER/BRAND		MAX USER WEIGHT	
Amtech Medical Aid		N/A	
SUPPLIER PRODUCT ID	ENZ LIST CODE	ACC SIC CODE	
SU434	ENZA62	EK106	

Seat & Back Cushion			Simple
		SPECIFICATIONS	
		Obusforme high back rest 78cmx43cm	
SUPPLIER/BRAND		MAX USER WEIGHT	
Amtech Medical Aid		N/A	
SUPPLIER PRODUCT ID	ENZ LIST CODE	ACC SIC CODE	
SU435	ENZA73	EK108	

ACC Simple List Equipment

Daily Living Aids

Exercise & Therapy			Simple
		SPECIFICATIONS	
		Xterra U15 Exercise bike Battery operated Console Height adjustable seat range (660-1000mm) Height adjustable seat (560-900 seat to pedal) Note: Fuel 3.0 will be issued if reissue stock is available	
SUPPLIER/BRAND		MAX USER WEIGHT	
Bernsport		120kg	
SUPPLIER PRODUCT ID	ENZ LIST CODE	ACC SIC CODE	
DYXT000	ENZA172	EO003	

Exercise & Therapy			Simple
		SPECIFICATIONS	
		Fortress Tens physical therapy with standard accessories (Electrodes) 1000x610x1420mm	
SUPPLIER/BRAND		MAX USER WEIGHT	
Amtech Medical Aid		N/A	
SUPPLIER PRODUCT ID	ENZ LIST CODE	ACC SIC CODE	
PD100	ENZA39	EO101	

ACC

Standard List Equipment

Table of Contents

Bedroom	46
Kitchen & Living	47
Office	48
Patient Lifters	49
Shower & Bath	53
Wheelchair & Seating	54

ACC Standard List Equipment

Bedroom

Bed & Accessories			Standard
		SPECIFICATIONS	
		Bed Etude Plus 4 section Hi-Lo Includes bed ends Accessories below 2190x1020mm overall size 330-730 or 400-800mm adjustable height	
SUPPLIER/BRAND		MAX USER WEIGHT	
Invacare/Etude		165kg	
SUPPLIER PRODUCT ID	ENZ LIST CODE	ACC SIC CODE	
PKG-ETUDE PLUS STD	ENZA204	EC102	
ACCESSORIES			
DESCRIPTION	ENZ LIST CODE	SUPPLIER PRODUCT ID	ACC SIC CODE
Bed Extn 15cm incl mattress	ENZA115	BEDEXTKITP10	EC101
Cotside 3/4 Foldable Right	ENZA95	1528931-7035	EC111
Cotside 3/4 foldable Left	ENZA94	1529272-7035	EC111
Overbed pole	ENZA89	154093-0152	EC130

Mattress			Standard
		SPECIFICATIONS	
		Softform premier 1970x800x152mm	
SUPPLIER/BRAND		MAX USER WEIGHT	
Invacare/Softform		247.6kg	
SUPPLIER PRODUCT ID	ENZ LIST CODE	ACC SIC CODE	
1486720	ENZA176	EC123	

ACC Standard List Equipment

Kitchen & Living

Lift Out Chair		Standard
		SPECIFICATIONS
		Dual motor Rechargeable battery backup Removable back 900mm overall width 440mm width between arms 530mm seat depth
SUPPLIER/BRAND		MAX USER WEIGHT
Goldfern Mobility		150kg
SUPPLIER PRODUCT ID	ENZ LIST CODE	ACC SIC CODE
GM-HYE-8063	ENZA67	EK120

ACC Standard List Equipment

Office

Office Chair		Standard
	SPECIFICATIONS	
	Chorus 3.5 high back chair 3 Lever Black Back 470mm 420-550mm adjustable height 480mmx490mm seat size	
SUPPLIER/BRAND		MAX USER WEIGHT
Bytes & Pieces		110kg
SUPPLIER PRODUCT ID	ENZ LIST CODE	ACC SIC CODE
E-Chorus3.50	ENZA146	EF115

Hi Lo Desk		Standard
	SPECIFICATIONS	
	Hi Lo electric desk 1200mmx800mm 620-1275mm adjustable height	
SUPPLIER/BRAND		MAX USER WEIGHT
Bytes & Pieces		N/A
SUPPLIER PRODUCT ID	ENZ LIST CODE	ACC SIC CODE
OI-01	ENZA193	EF120

ACC Standard List Equipment

Patient Lifters

Hoist		Standard	
		SPECIFICATIONS	
		Birdie Evo Compact Manual Legs Hoist frame with Pivot or Spreader bar 520mm overall width closed (external) 815mm Internal width legs open 1070mm turning radius Lifting range 530mm -1590mm	
SUPPLIER/BRAND		MAX USER WEIGHT	
Invacare/Birdie		150kg	
SUPPLIER PRODUCT ID	ENZ LIST CODE	DESCRIPTION	ACC SIC CODE
PKG-EVOCOMPACTPIVOT	ENZA11472	Birdie Evo Compact with Pivot	EH110
PKG-EVOCOMPACTSTD	ENZA11473	Birdie Evo Compact with Spreader	EH110

Hoist		Standard	
		SPECIFICATIONS	
		Birdie Evo Electric Legs Hoist with Pivot or Spreader Bar 640mm overall width closed (external) 1020mm Internal width legs open 1400mm turning radius Lifting range 415mm -1660mm	
SUPPLIER/BRAND		MAX USER WEIGHT	
Invacare/Birdie		180kg	
SUPPLIER PRODUCT ID	ENZ LIST CODE	DESCRIPTION	ACC SIC CODE
PKG-EVO180PIVOT	ENZA11470	Birdie Evo with Pivot	EH111
PKG-EVO180STD	ENZA11471	Birdie Evo with Spreader	EH111

ACC Standard List Equipment

Patient Lifters

Yoke Sling				Standard
		SPECIFICATIONS		
		Universal High sling Fabric For use with Birdie Evo and Birdie Evo Compact hoists		
SUPPLIER/BRAND		MAX USER WEIGHT		
Invacare/Optisling		N/A		
SUPPLIER PRODUCT ID	ENZ LIST CODE	SIZE	ACC SIC CODE	
60124058	ENZA148	X-Small	EH117	
60124059	ENZA149	Small	EH117	
60124060	ENZA150	Medium	EH117	
60124061	ENZA151	Large	EH117	
60124062	ENZA152	X-Large	EH117	

Yoke Sling				Standard
		SPECIFICATIONS		
		Universal High sling Mesh For use with Birdie Evo and Birdie Evo Compact hoists		
SUPPLIER/BRAND		MAX USER WEIGHT		
Invacare/Optisling		N/A		
SUPPLIER PRODUCT ID	ENZ LIST CODE	SIZE	ACC SIC CODE	
60124064	ENZA153	Small	EH117	
60124065	ENZA154	Medium	EH117	
60124066	ENZA155	Large	EH117	
60124067	ENZA156	XLarge	EH117	

ACC Standard List Equipment

Patient Lifters

Yoke Sling				Standard
		SPECIFICATIONS		
		Hygiene High sling Fabric For use with Birdie Evo and Birdie Evo Compact hoists		
SUPPLIER/BRAND		MAX USER WEIGHT		
Invacare/Optisling		N/A		
SUPPLIER PRODUCT ID	ENZ LIST CODE	SIZE	ACC SIC CODE	
60123894	ENZA157	X-Small	EH117	
60123895	ENZA158	Small	EH117	
60123896	ENZA159	Medium	EH117	
60123897	ENZA160	Large	EH117	
60123898	ENZA161	X-Large	EH117	

Pivot Sling				Standard
		SPECIFICATIONS		
		Pivot sling General Purpose with Head Support Mesh For use with the Birdie Compact with pivot attachment		
SUPPLIER/BRAND		MAX USER WEIGHT		
Invacare/Novis		N/A		
SUPPLIER PRODUCT ID	ENZ LIST CODE	SIZE	ACC SIC CODE	
SL146191	ENZA162	Small	EH117	
SL146291	ENZA163	Medium	EH117	
SL146391	ENZA164	Large	EH117	

ACC Standard List Equipment

Patient Lifters

Pivot Sling			Standard
		SPECIFICATIONS	
		Pivot sling Hygiene Mesh For use with the Birdie Compact with pivot attachment	
SUPPLIER/BRAND		MAX USER WEIGHT	
Invacare/Novis		N/A	
SUPPLIER PRODUCT ID	ENZ LIST CODE	SIZE	ACC SIC CODE
SL247191	ENZA165	Small	EH117
SL247291	ENZA166	Medium	EH117
SL247391	ENZA167	Large	EH117

ACC Standard List Equipment

Shower & Bath

Bath Lifter			Standard
		SPECIFICATIONS	
		Bath lift Orca XL 375mm seat width without side flaps 715mm seat width with side flaps 580x285mm base area	
SUPPLIER/BRAND		MAX USER WEIGHT	
Invacare/Aquatech		170kg	
SUPPLIER PRODUCT ID	ENZ LIST CODE	ACC SIC CODE	
1573744	ENZA179	EH102	

Bath Lifter			Standard
		SPECIFICATIONS	
		Bath lift Bexley 395mm seat width without side flaps 580mm seat width with side flaps 340x650mm base area	
SUPPLIER/BRAND		MAX USER WEIGHT	
Cubro/Bexley		170kg	
SUPPLIER PRODUCT ID	ENZ LIST CODE	ACC SIC CODE	
340	ENZA220	EH101	

ACC Standard List Equipment

Wheelchair & Seating

Wheelchair - Transit Peadiatric				Standard
		SPECIFICATIONS		
		Manual Action 3 Transit Junior Base unit includes: Action 3 Junior <ul style="list-style-type: none"> • Wheelchair sizes: 8-11x10-12, 8-11x12-14, 12-15x11-13, 12-15x13-15 • Available in two colours – Matte Red and Polar Blue • Front castor Wheels 5" • Transit wheels 12" • Leg rest hangers available in 80 degree swing away or 90 degree • Footrests Flip Up Angle and Depth adjustable • Seat Upholstery Nylon adjustable • Back Upholstery Nylon adjustable • Back Canes fixed height 0 degree • Armrests removable height adjustable with skirt guard • Push to Lock Brakes • Seat Belt • Anti-Tippers 		
SUPPLIER/BRAND		MAX USER WEIGHT		
Invacare/Action 3		80kg		
SUPPLIER PRODUCT ID	ENZ LIST CODE	COLOUR	SIZE	ACC SIC CODE
EF1672195-TR	ENZA216	BLUE	8-11x10-12	EM071
EF1672197-TR	ENZA217	BLUE	8-11x12-14	EM071
EF1672199-TR	ENZA218	BLUE	12-15x11-13	EM071
EF1672201-TR	ENZA219	BLUE	12-15x13-15	EM071
EF1672194-TR	ENZA12113	RED	8-11x10-12	EM071
EF1672196-TR	ENZA12112	RED	8-11x12-14	EM071
EF1672198-TR	ENZA12111	RED	12-15x11-13	EM071
EF1672200-TR	ENZA12110	RED	12-15x13-15	EM071

ACC Standard List Equipment

Wheelchair & Seating

Wheelchair - Self Propelling Peadiatric				Standard
		SPECIFICATIONS		
		<p>Action 3 Junior Folding Frame</p> <p>Base unit includes:</p> <p>Action 3 Junior</p> <ul style="list-style-type: none"> • Wheelchair sizes: 8-11x10-12, 8-11x12-14, 12-15x11-13, 12-15x13-15 • Available in two colours – Matte Red and Polar Blue • Self Propelling (22" rear wheel) • Front castor Wheels 5" • Leg rest hangers available in 80 degree swing away or 90 degree • Footrests Flip Up Angle and Depth adjustable • Seat Upholstery Nylon adjustable • Back Upholstery Nylon adjustable • Back Canes fixed height 0 degree • Armrests removable height adjustable with skirt guard • Push to Lock Brakes • Seat Belt • Anti-Tippers 		
SUPPLIER/BRAND		MAX USER WEIGHT		
Invacare/Action 3		80kg		
SUPPLIER PRODUCT ID	ENZ LIST CODE	COLOUR	SIZE	ACC SIC CODE
EF1672195	ENZA212	BLUE	8-11x10-12	EM070
EF1672197	ENZA213	BLUE	8-11x12-14	EM070
EF1672199	ENZA214	BLUE	12-15x11-13	EM070
EF1672201	ENZA215	BLUE	12-15x13-15	EM070
EF1672194	ENZA12117	RED	8-11x10-12	EM070
EF1672196	ENZA12116	RED	8-11x12-14	EM070
EF1672198	ENZA12115	RED	12-15x11-13	EM070
EF1672200	ENZA12114	RED	12-15x13-15	EM070

ACC Standard List Equipment

Wheelchair & Seating

Wheelchair - Self Propelling Paediatric			Standard
		SPECIFICATIONS	
		Manual self propelling Karma Flexx Junior Folding Frame <ul style="list-style-type: none"> • Quick release 20" rear wheels • 5" front castor • Standard 2 point hip belt • Height adjustable, flip back armrests • Heel loops • 90 degree legrests with fixed angle foot rest • Back angle adjustment (-4° to 16°) • Removable anti-tippers • Push to lock brakes 	
SUPPLIER/BRAND		MAX USER WEIGHT	
Allied Medical/Karma Flexx		75kg	
SUPPLIER PRODUCT ID	ENZ LIST CODE	SIZE	ACC SIC CODE
KMFLEXXSPJR1011	ENZA207	10x11	EM064
KMFLEXXSPJR1212	ENZA208	12x12	EM064
KMFLEXXSPJR1414	ENZA209	14x14	EM064
ACCESSORIES			
DESCRIPTION	ENZ LIST CODE	SUPPLIER PRODUCT ID	ACC SIC CODE
Elevating legrest Left	ENZA99	KM390600000016	EM065
Elevating legrest Right	ENZA100	KM390600000015	EM066

ACC Standard List Equipment

Wheelchair & Seating

Wheelchair Standard Minimal-Adjustable				Standard
		SPECIFICATIONS Karma Flexx Folding Base unit includes: Karma Flexx Wheelchair sizes: 14x16, 16x16, 16x18, 16x20, 18x16, 18x18, 18x20 <ul style="list-style-type: none"> • Standard seat and back upholstery • 7" castor • 24" pneumatic rear wheel with quick release axle (Self Propelled) or 14" rear wheel (Transit) • Height adjustable, flip back desk armrest • Calf strap • 80 deg legrests with fixed angle foot rest • 2point hip belt • Back angle adjustment (-4° to +16°) • Removable antitipper • Push to lock brakes • Fixed back canes Flexx height 17" • Fixed back canes Flexx Tall height 20" Option extra adjustable Back Canes <ul style="list-style-type: none"> • Adjustable back canes 15-20" 		
		SUPPLIER/BRAND Allied Medical/Karma		MAX USER WEIGHT 130kg
DESCRIPTION	ENZ LIST CODE	SUPPLIER PRODUCT ID	SIZE	ACC SIC CODE
Karma Flexx Transit base unit	ENZA7965	KMFLEXXSTR1416	14X16	EM160
	ENZA5239	KMFLEXXSTR1616	16X16	EM161
	ENZA6434	KMFLEXXSTR1618	16X18	EM162
	ENZA6727	KMFLEXXSTR1816	18X16	EM163
	ENZA6683	KMFLEXXSTR1818	18X18	EM164
Karma Flexx Tall Transit base unit	ENZA7966	KMFLEXXTLTR1620	16X20	EM165
	ENZA7967	KMFLEXXTLTR1820	18X20	EM166
Karma Flexx Self Propelled base unit	ENZA847	KMFLEXXSP1416	14X16	EM167
	ENZA844	KMFLEXXSP1616	16X16	EM168
	ENZA845	KMFLEXXSP1618	16X18	EM169
	ENZA7968	KMFLEXXSP1816	18X16	EM170
	ENZA1518	KMFLEXXSP1818	18X18	EM171
Karma Flexx Tall Self Propelled base unit	ENZA7406	KMFLEXXTLSP1620	16X20	EM172
	ENZA841	KMFLEXXTLSP1820	18X20	EM173
ACCESSORIES				
DESCRIPTION	ENZ LIST CODE	SUPPLIER PRODUCT ID	ACC SIC CODE	
Elevating Legrest 14 LHS	ENZA9046	KMFLEXXELA14L	EM192	
Elevating Legrest 14 RHS	ENZA9047	KMFLEXXELA14R	EM193	
Elevating Legrest 16 LHS	ENZA7977	KMFLEXXELA16L	EM186	
Elevating Legrest 16 RHS	ENZA7407	KMFLEXXELA16R	EM187	
Elevating Legrest 18-20 LHS	ENZA9048	KMFLEXXELA1820L	EM194	
Elevating Legrest 18-20 RHS	ENZA9049	KMFLEXXELA1820R	EM195	

ACC Standard List Equipment

Wheelchair & Seating

Wheelchair Standard Minimal-Adjustable		Standard		
		SPECIFICATIONS		
		<p>Karma Flexx HD Folding Base unit includes: Karma Flexx HD Wheelchair sizes: 20x18, 20x20, 22x18, 22x20, 24x18</p> <ul style="list-style-type: none"> • Standard seat and back upholstery • 7" castor • 24" pneumatic rear wheel with quick release axle (Self Propelled) or 14" rear wheel (Transit) • Height adjustable, flip back desk armrest • Heel loops • 80 deg legrests with fixed angle foot rest • 2point hip belt • Back angle adjustment (-4° to +16°) • Removable antitipper • Push to lock brakes • Rigidising Bar (which doubles as a push handle) • Fixed back canes Flexx HD height 17" <p>Option extra adjustable Back Canes</p> <ul style="list-style-type: none"> • Adjustable back canes 15-20" 		
SUPPLIER/BRAND		MAX USER WEIGHT		
Allied Medical/Karma		170kg		
DESCRIPTION	ENZ LIST CODE	SUPPLIER PRODUCT ID	SIZE	ACC SIC CODE
Karma Flexx HD Transit base unit	ENZA3525	KMFLEXXHDTR2018	20x18	EM174
	ENZA7969	KMFLEXXHDTR2020	20x20	EM175
	ENZA7970	KMFLEXXHDTR2218	22x18	EM176
	ENZA7972	KMFLEXXHDTR2220	22x20	EM177
	ENZA7973	KMFLEXXHDTR2418	24x18	EM178
	ENZA7974	KMFLEXXHDTR2420	24x20	EM179
Karma Flexx HD Self Propelled base unit	ENZA843	KMFLEXXHDSP2018	20x18	EM180
	ENZA842	KMFLEXXHDSP2020	20x20	EM181
	ENZA7975	KMFLEXXHDSP2218	22x18	EM182
	ENZA2194	KMFLEXXHDSP2220	22x20	EM183
	ENZA4997	KMFLEXXHDSP2418	24x18	EM184
	ENZA7976	KMFLEXXHDSP2420	24x20	EM185
ACCESSORIES				
DESCRIPTION	ENZ LIST CODE	SUPPLIER PRODUCT ID	ACC SIC CODE	
Elevating Legrest 14 LHS	ENZA9046	KMFLEXXELA14L	EM192	
Elevating Legrest 14 RHS	ENZA9047	KMFLEXXELA14R	EM193	
Elevating Legrest 16 LHS	ENZA7977	KMFLEXXELA16L	EM186	
Elevating Legrest 16 RHS	ENZA7407	KMFLEXXELA16R	EM187	
Elevating Legrest 18-20 LHS	ENZA9048	KMFLEXXELA1820L	EM194	
Elevating Legrest 18-20 RHS	ENZA9049	KMFLEXXELA1820R	EM195	

ACC Standard List Equipment

Wheelchair & Seating

Wheelchair - Transit			Standard
		SPECIFICATIONS	
		Manual Action 3 Transit 12" Wheels 8" Castors	
SUPPLIER/BRAND		MAX USER WEIGHT	
Invacare/Action 3		125kg	
SUPPLIER PRODUCT ID	ENZ LIST CODE	SIZE	ACC SIC CODE
CS1567978	ENZA182	16x16	EM055
CS1552784	ENZA183	18x18	EM055
CS1567979	ENZA184	18x16	EM055
CS1552843	ENZA185	18x18	EM055
CS1552844	ENZA186	20x18	EM055

Wheelchair - Transit			Standard
		SPECIFICATIONS	
		Manual Action 3 self propelling 24" Wheels 8" Castors	
SUPPLIER/BRAND		MAX USER WEIGHT	
Invacare/Action 3		125kg	
SUPPLIER PRODUCT ID	ENZ LIST CODE	SIZE	ACC SIC CODE
CS1567975	ENZA187	16x16	EM056
CS1552711	ENZA188	18x18	EM056
CS1567976	ENZA189	18x16	EM056
CS1552769	ENZA190	18x18	EM056
CS1552770	ENZA191	20x18	EM056

ACC

Complex List Equipment

Table of Contents

Bedroom	60
Shower & Bath	61
Wheelchair & Seating	63

ACC Complex List Equipment

Bedroom

Bed		Complex	
		SPECIFICATIONS	
		Bock Belluno 4 section bed 1030x2160mm size 70 degrees angle adjustment 150mm clearance height	
SUPPLIER/BRAND		MIN/MAX USER WEIGHT	
Cubro/Bock		MIN 40kg MAX 165kg	
SUPPLIER PRODUCT ID	ENZ LIST CODE	SIZE	ACC SIC CODE
921/WA	ENZA237	110cm Super single	EC103
922/WA	ENZA239	140cm Double	EC104

Mattress		Complex	
		SPECIFICATIONS	
		Posture Temp pressure relieving mattress 150mm height Sizes below	
SUPPLIER/BRAND		USER WEIGHT RANGE	
Cubro/Posture Temp		20-120kg	
SUPPLIER PRODUCT ID	ENZ LIST CODE	SIZE	ACC SIC CODE
994	ENZA210	Super Single 1100x2000mm	EC124
992	ENZA221	Double 1400x2000mm	EC125

ACC Complex List Equipment

Shower & Bath

Shower Cubicle			Complex
		SPECIFICATIONS	
		Careport extra freestanding shower system incl doors,ramp Pump Control Unit Shower slide & mixer Handrails (excl installation) 1200x1400x2100mm PLEASE NOTE: QUOTE IS REQUIRED WITH REQUEST & MUST BE PART OF AN APPROVED HOUSING MODIFICATION SERVICE	
SUPPLIER/BRAND		MAX USER WEIGHT	
Active Healthcare/Careport		N/A	
SUPPLIER PRODUCT ID	ENZ LIST CODE	ACC SIC CODE	
0151-0801	ENZA223	EB110	

Shower Commode			Complex
		SPECIFICATIONS	
		Shower commode self propelled Frame only 460mm width between arms Seat not included please select accessories below	
SUPPLIER/BRAND		MAX USER WEIGHT	
Cubro/Viking		200kg	
SUPPLIER PRODUCT ID	ENZ LIST CODE	ACC SIC CODE	
966	ENZA223	EB121	
ACCESSORIES			
DESCRIPTION	ENZ LIST CODE	SUPPLIER PRODUCT ID	ACC SIC CODE
Closed Seat	ENZA3456	75PC/75PR	
Open Seat	ENZA3455	75PO/75PR	

ACC Complex List Equipment

Shower & Bath

Shower Commode			Complex
		SPECIFICATIONS	
		Shower commode Attendant propelled Frame only 460mm width between arms Seat not included please select accessories below	
SUPPLIER/BRAND		MAX USER WEIGHT	
Cubro/Viking		200kg	
SUPPLIER PRODUCT ID	ENZ LIST CODE	ACC SIC CODE	
960	ENZA222	EB122	
ACCESSORIES			
DESCRIPTION	ENZ LIST CODE	SUPPLIER PRODUCT ID	ACC SIC CODE
Closed Seat	ENZA3456	75PC/75PR	
Open Seat	ENZA3455	75PO/75PR	

Shower Commode			Complex
		SPECIFICATIONS	
		Viking RAZ TNS Base unit includes: <ul style="list-style-type: none"> Viking RAZ TNS 16,18 and 20 Adjusta-Back - 430mm (20") H Fabric back, 20" high Molded Headrest - incl. stainless steel fixing RAZ Molded Seat 450mmW x 400mmD - Set of clips etc to fit seats on RAZ commodes H-Strap (attached to footrests for calf support) Adjustable Footrest 410-520mm PLEASE NOTE: QUOTE IS REQUIRED WITH REQUEST.	
SUPPLIER/BRAND		MAX USER WEIGHT	
Cubro/Raz		185kg	
SUPPLIER PRODUCT ID	ENZ LIST CODE	SIZE	ACC SIC CODE
9902	ENZA260	16" Open Seat Base Unit	EB125
9904	ENZA261	18" Open Seat Base Unit	EB125
9906	ENZA262	20" Open Seat Base Unit	EB125
9903	ENZA263	16" Closed Seat Base Unit	EB125
9905	ENZA264	18" Closed Seat Base Unit	EB125
9907	ENZA265	20" Closed Seat Base Unit	EB125

ACC Complex List Equipment

Wheelchair & Seating

Wheelchair - Tilt n Space				Complex
		SPECIFICATIONS Solara 3G Rigid Base unit includes: Solara 3G <ul style="list-style-type: none"> • Frame sizes: 12-24x12-22 • Width and Depth Adjustable Frame • Tilt in Space Frame • Stroller Handles • Foot operated brake • Foot operated tilt • 12" or 24" Rear Wheels • 70 Degree Swingaway Legrests with angle adjustable footplates • Dual post flip back, height adjustable armrest with full-length armpad • 2 Point Freedom belt • Tie Downs • Colour Black 		
		PLEASE NOTE: QUOTE IS REQUIRED WITH REQUEST.		
SUPPLIER/BRAND		MAX USER WEIGHT		
Invacare/Solara		136kg		
SUPPLIER PRODUCT ID	ENZ LIST CODE	SIZE	ACC SIC CODE	
SOLARA3G-C	ENZA251	14-18x15-19	EM105	
SOLARA3G-B	ENZA252	14-18x12-16	EM105	
SOLARA3G-D	ENZA253	16-20x15-19	EM105	
SOLARA3G-E	ENZA254	16-20x18-22	EM105	

Wheelchair - Tilt n Space				Complex
		SPECIFICATIONS Pro CG tilt n space wheelchair 15"-19" (-1.5" with drop base) 0 - 50 degree Tilt n Space range 12 1/2" Transit wheels PLEASE NOTE: QUOTE IS REQUIRED WITH REQUEST.		
		PLEASE NOTE: QUOTE IS REQUIRED WITH REQUEST.		
SUPPLIER/BRAND		MAX USER WEIGHT		
Invacare/Pro CG		113kg		
SUPPLIER PRODUCT ID	ENZ LIST CODE	SIZE	ACC SIC CODE	
	ENZA255	12-14x12-16	EM126	
	ENZA256	14-16x14-18	EM126	
	ENZA257	16-18x16-20	EM126	
	ENZA258	18-20x18-22	EM126	

ACC Complex List Equipment

Wheelchair & Seating

Wheelchair - Tilt n Space		Complex	
		SPECIFICATIONS Zippie Iris Rigid Base unit includes: Zippie Iris Frame sizes: 10-14x10-18 <ul style="list-style-type: none"> • True-ft growth system • Tie downs • Width adjusting system • Short, medium and long seat frame • 5" x 1.5" semi pneumatic front castors • 16" Rear mag wheels; pneumatic • 90° legrest hangers with angle adjustable footplates • Offset hanger mounts • Single post height adjustable arm supports with full-length pads • Height adjustable push handle • Growable seat pan • Anti-tips • Black Opal frame colour • Foot operated tilt • Foot operated brakes 	
		Accessories: ENZ LIST CODE: ENZA14 ACC SIC CODE: EM151A Click here for script form PLEASE NOTE: QUOTE & ACCESSORY CODE IS REQUIRED WITH REQUEST.	
SUPPLIER/BRAND		MAX USER WEIGHT	
Medifab/Zippie		135kg	
SUPPLIER PRODUCT ID	ENZ LIST CODE	SIZE (width x depth)	ACC SIC CODE
1562	ENZA241	12-19x12-19	EM151
1562	ENZA5763	12-19x20 & 20x12-19	EM151
1562	ENZA5764	20x20	EM151
1562	ENZA5765	10-14x10-18	EM151

ACC Complex List Equipment

Wheelchair & Seating

Wheelchair - Tilt n Space		Complex	
		SPECIFICATIONS Quickie Iris Rigid Base unit includes: Quickie Iris Medium Frame sizes: 14-20x16-20 <ul style="list-style-type: none"> • True-ft growth system • Tie downs • Width adjusting system • Medium seat frame • 6" x 1.5" semi pneumatic front castors • 16" Rear mag wheels; pneumatic • 80° legrest hangers with angle adjustable footplates • Single post height adjustable arm supports with full-length pads • Height adjustable push handle • Growable seat pan • Anti-tips • Black Opal frame colour • Foot operated tilt and brakes Quickie Iris Long Frame sizes: 14-20x18-22 <ul style="list-style-type: none"> • True-ft growth system • Tie downs • Width adjusting system • Long seat frame • 6" x 1.5" semi pneumatic front castors • 16" Rear mag wheels; pneumatic • 80° legrest hangers with angle adjustable footplates • Single post height adjustable arm supports with full-length pads • Height adjustable push handle • Growable seat pan • Anti-tips • Black Opal frame colour • Foot operated tilt and brakes Accessories: ENZ LIST CODE: ENZA15 ACC SIC CODE: EM152A Click here for script form PLEASE NOTE: QUOTE & ACCESSORY CODE IS REQUIRED WITH REQUEST.	
		SUPPLIER/BRAND Medifab/Quickie	
SUPPLIER PRODUCT ID	ENZ LIST CODE	SIZE (width x depth)	ACC SIC CODE
1567-00	ENZA248	14-20x16-20	EM152
1567-01	ENZA259	14-20x18-22	EM155

ACC Complex List Equipment

Wheelchair & Seating

Wheelchair - Manual- Fully Configurable		Complex	
		SPECIFICATIONS Kushall Compact Attract Folding <ul style="list-style-type: none"> • Seat height : Front 430-520mm • Seat height : Rear 400-490mm • 24" rear wheels • Total width - seat width + 18cm • Total width folded 30cm • Total length 70degree: 985mm, 90degree: 895mm, w/ out legrest: 690mm PLEASE NOTE: QUOTE IS REQUIRED WITH REQUEST.	
		SUPPLIER/BRAND Invacare/Kushall	
SUPPLIER/BRAND		MAX USER WEIGHT 130kg	
SUPPLIER PRODUCT ID		ACC SIC CODE	
ENZ LIST CODE		SIZE	
COMPACT-ATT-BLK-A	ENZA227	16x16	EM127
COMPACT-ATT-BLK-B	ENZA228	16x18	EM127
COMPACT-ATT-BLK-C	ENZA229	18x18	EM127
COMPACT-ATT-BLK-D	ENZA230	18x20	EM127
COMPACT-ATT-BLK-E	ENZA231	20x20	EM127
COMPACT-ATT-BLK-F	ENZA232	18x16	EM127
COMPACT-ATT-BLK-G	ENZA233	14x16	EM127
COMPACT-ATT-BLK-H	ENZA234	20x18	EM127

ACC Complex List Equipment

Wheelchair & Seating

Wheelchair- Fully Configurable		Complex	
		SPECIFICATIONS	
		<p>TiLite AeroX Folding</p> <p>Base unit includes:</p> <p>AeroX</p> <ul style="list-style-type: none"> • Swingaway Legrests 85 deg standard, also available in 70, 80 and 90 deg, as well as fixed front end • Composite Flip Up Footplates height adjustable • Composite Casters either 4, 5, or 6" • Composite Push or Pull 2 Lock Brakes • Seat upholstery and padded backrest upholstery adjustable slide in seat sling • Height Adjustable Fixed Angle Back Canes 90 deg or with 8 deg bend • Integrated Push Handles • TiLite Shadow Rear Wheel 22", 24", 25" or 26" • Silver Anodized Handrim • Tyre Treaded or Smooth • TiLite Stainless Quick Release Axles • Camber 0, 2, 4, 6 deg • Fully adjustable seat-to-floor heights and centre of gravity • Colour red, blue, black or silver <p>Accessories: ENZ LIST CODE: ENZA8 ACC SIC CODE: EM135A</p> <p>Click here for script form</p> <p>PLEASE NOTE: QUOTE & ACCESSORY CODE IS REQUIRED WITH REQUEST.</p>	
SUPPLIER/BRAND		MAX USER WEIGHT	
Permobil/TiLite		120kg standard and 159kg heavy duty	
SUPPLIER PRODUCT ID	ENZ LIST CODE	SIZE (width x depth)	ACC SIC CODE
AXFS1	ENZA226	12-22x12-20	EM135

ACC Complex List Equipment

Wheelchair & Seating

Wheelchair Fully Configurable		Complex	
		SPECIFICATIONS Quickie 2 Folding Base unit includes: Quickie 2 <ul style="list-style-type: none"> • DAB depth & angle adjustable backrest • 24" lite spoke rear wheels • Anodised push rims • Marathon plus tyres • 5" x 1.5" semi-pneumatic castors • Single post height adjustable armrests with full length-pads • 80 degree swingaway footrest hangers • Aluminium angle adjustable footplates • 16" high 3DX tension adjustable back upholstery • Integrated push handles • Anti-tips • Colour is black opal 	
		Accessories: ENZ LIST CODE: ENZA3 ACC SIC CODE: EM153A Click here for script form PLEASE NOTE: QUOTE & ACCESSORY CODE IS REQUIRED WITH REQUEST.	
SUPPLIER/BRAND		MAX USER WEIGHT	
Medifab/Quickie		136kg standard and 158kg heavy duty	
SUPPLIER PRODUCT ID	ENZ LIST CODE	SIZE (width x depth)	ACC SIC CODE
1571	ENZA238	12-19x12-19	EM150
1571	ENZA240	12-19x20 & 20x12-19	EM153
1571-2020-001	ENZA250	20x20	EM154

ACC Complex List Equipment

Wheelchair & Seating

Wheelchair Rigid - Z Style		Complex	
		SPECIFICATIONS	
		<p>TiLite ZRA Rigid</p> <p>Base unit includes:</p> <p>ZRA</p> <ul style="list-style-type: none"> • Front Frame Angle 85 deg standard, also available in 70, 80 and 90 deg, as well as fixed front end • Footrest Width Taper no taper, 1.5" or 3.5" • Angle Adjustable Footplate height adjustable • Composite Casters 4, 5, or 6" • Composite Push or Pull 2 Lock Brakes • Bolt-On Tension Adj. Seat Upholstery • Padded Backrest Upholstery • Height/Angle adjustable Folding Backrest • Aluminium Back Release Bar • Integrated Push Handles • Aluminium Camber Tube 0, 2, 4, 6 Deg Camber • TiLite Shadow Rear Wheel 20", 22", 24", 25" or 26" • Silver Anodized Handrim • Tyre Treaded or Smooth • TiLite Stainless Quick Release Axles • Camber 0, 2, 4 or 6 deg • Fully adjustable seat-to-floor heights and centre of gravity • Colour red, blue, black or titanium satin" <p>Accessories: ENZ LIST CODE: ENZA7 ACC SIC CODE: EM133A</p> <p>Click here for script form</p> <p>PLEASE NOTE: QUOTE & ACCESSORY CODE IS REQUIRED WITH REQUEST.</p>	
SUPPLIER/BRAND		MAX USER WEIGHT	
Permobil/TiLite		120kg standard and 136kg Heavy Duty	
SUPPLIER PRODUCT ID	ENZ LIST CODE	SIZE (width x depth)	ACC SIC CODE
Z2FS2	ENZA249	10-20x10-20	EM133

ACC Complex List Equipment

Wheelchair & Seating

Wheelchair Rigid - Z Style

Complex



SPECIFICATIONS

Hawk
Rigid

Base unit includes:

Hawk Aluminium

Frame sizes: 16-20x16-20 in inch increments

- Fixed front
- 4,5 or 6" castor, narrow or wide with plastic hub
- Push to lock brakes
- Anti-tips
- Standard wheel sizes 24 to 26"
- Standard Sling and Tension adjustable back upholstery
- Leg strap
- Impact guards
- Colour Red, blue, black or silver

Hawk Titanium

Frame sizes: 16-20x16-20 in inch increments

- Fixed front
- 4,5 or 6" castor, narrow or wide with plastic hub
- Push to lock brakes
- Anti-tips
- Standard wheel sizes 24 to 26"
- Standard Sling and Tension adjustable back upholstery
- Leg strap
- Impact guards
- Colour standard titanium finish

Accessories: Aluminium

ENZ LIST CODE: ENZA10

ACC SIC CODE: EM140A

Accessories: Titanium

ENZ LIST CODE: ENZA11

ACC SIC CODE: EM141A

[Click here for script form](#)

PLEASE NOTE: QUOTE & ACCESSORY CODE IS REQUIRED WITH REQUEST.

SUPPLIER/BRAND

Melrose Kiwi Concept Chairs/Hawk

MAX USER WEIGHT

100kg

SUPPLIER PRODUCT ID	ENZ LIST CODE	OPTIONS	SIZE	ACC SIC CODE
90420A	ENZA247	Aluminium	16-20x16-20	EM140
90420	ENZA266	Titanium	16-20x16-20	EM141

ACC Complex List Equipment

Wheelchair & Seating

Wheelchair Rigid - Rigid Z Style		Complex	
		SPECIFICATIONS Ki Rogue Rigid Base unit includes: Ki Rogue Frame sizes: 12-19x14-19 <ul style="list-style-type: none"> • Tubular open footplate • Selection of 70,75,80 or 85 • 3,4,5 or 6" x 1 poly castor • Standard seat upholstery and padded backrest upholstery • Height adjust back canes • 20, 22, 24, 25, 26 standard spoke wheels and • Aluminum anodised pushrims, street pneumatic tyre-sand quick release axles • Brake options push to lock, push to lock flush mountor pull to lock • 0,2,4,6, or 8 deg camber 	
		Accessories: ENZ LIST CODE: ENZA12 ACC SIC CODE: EM142A Click here for script form PLEASE NOTE: QUOTE & ACCESSORY CODE IS REQUIRED WITH REQUEST.	
SUPPLIER/BRAND		MAX USER WEIGHT	
Allied Medical/ Ki		100kg	
SUPPLIER PRODUCT ID	ENZ LIST CODE	SIZE (width x depth)	ACC SIC CODE
KIROGUEXXXXXX	ENZA236	12-19x14-19	EM142

ACC Complex List Equipment

Wheelchair & Seating

Wheelchair - Rigid Z Style		Complex	
		SPECIFICATIONS	
		<p>APEX Aluminium Rigid</p> <ul style="list-style-type: none"> • Wheel Size 20", 26" • AluLite Aluminium alloy Frame – Stronger and lighter than 7005 Aluminium • Fixed Largest – 80 deg Standard – also available in 90, 85, 75 and 70 deg • 1" Front frame taper Std but available with no taper • Adjustable Aluminium Angle Footplate • Aluminium Soft Roll Casters 5" std, also available in 4' and 6" • Push to Lock brakes – Composite – Also available in Pull to lock or Scissors brake • Seat upholstery • Tension Adjustable Back upholstery • Height and angle Adjustable folding back canes • Push handles • Newton Gravity Ultra light Rear Wheels • Aluminium Anodized push rims • HP tyre • Quick release axels • 4 deg Camber – Also available in 2, 6 and 8 Deg • Std colour option • Ultra Light carbon Fibre camber bar • Fully Adjustable Front and Rear Sea to to Floor heights (rear 14" to 20"/ Front 14" to 21") • 6" Centre of Gravity Adjustment • Weight Limit 120kg • Built in bubble levels for accurate caster adjustments <p>Accessories: ENZ LIST CODE: ENZA13 ACC SIC CODE: EM146A</p> <p>Click here for script form</p> <p>PLEASE NOTE: QUOTE & ACCESSORY CODE IS REQUIRED WITH REQUEST.</p>	
SUPPLIER/BRAND		MAX USER WEIGHT	
Custom Tech/Apex		120kg	
SUPPLIER PRODUCT ID	ENZ LIST CODE	SIZE (width x depth)	ACC SIC CODE
APEXA	ENZA246	14x16-20x18	EM146

ACC Complex List Equipment

Wheelchair & Seating

Wheelchair Self - Rigid Z Style		Complex	
		SPECIFICATIONS	
		<p>TiLite AeroZ Rigid</p> <p>Base unit includes:</p> <ul style="list-style-type: none"> • Front Frame Angle 85 deg standard, also available in 70, 80 and 90 deg, or custom angle • Footrest Width Taper no taper, 1.5" or 3.5" • Angle Adjustable Footplate height adjustable • Composite Casters 4, 5, or 6" • Composite Push or Pull 2 Lock Brakes • Bolt-On Tension Adj. Seat Upholstery • Padded Backrest Upholstery • Height/Angle adjustable Folding Backrest • Aluminium Back Release Bar • Integrated Push Handles • Aluminium Camber Tube 0, 2, 4, 6 Deg Camber • TiLite Shadow Rear Wheel 20", 22", 24", 25" or 26" • Silver Anodized Handrim • Tyre Treaded or Smooth • TiLite Stainless Quick Release Axles • Camber 0, 2, 4 or 6 deg • Fully adjustable seat-to-floor heights and centre of gravity • Colour red, blue, black or titanium grey <p>Accessories: ENZ LIST CODE: ENZA9 ACC SIC CODE: EM137A</p> <p>Click here for script form</p> <p>PLEASE NOTE: QUOTE & ACCESSORY CODE IS REQUIRED WITH REQUEST.</p>	
SUPPLIER/BRAND		MAX USER WEIGHT	
Permobil/TiLite		120kg	
SUPPLIER PRODUCT ID	ENZ LIST CODE	SIZE (width x depth)	ACC SIC CODE
AZFS1	ENZA235	10-20"x10"-20"	EM137

ACC Complex List Equipment

Wheelchair & Seating

Power Wheelchair		Complex	
		SPECIFICATIONS	
		Karma KP25 power chair Rear wheel drive Standard Folding <ul style="list-style-type: none"> • VR2 Electronics • 50-amp batteries • 70 degree swing away legrests • flip up - height adjustable armrests • Anti-tips • Battery charger • Floor to seat height 19" Min (21" available) • Overall width - seat width + 6.5" 	
SUPPLIER/BRAND		MAX USER WEIGHT	
Allied Medical/Karma		135kg	
SUPPLIER PRODUCT ID	ENZ LIST CODE	SIZE (width x depth)	ACC SIC CODE
KP251618L	ENZA242	16x18	EM103
KP251816L	ENZA243	18x16	EM103
KP251616L	ENZA244	16x16	EM103
KP251818L	ENZA245	18x18	EM103

ACC Complex List Equipment

Wheelchair & Seating

Power Wheelchair				Complex	
			SPECIFICATIONS Quantum Edge 3 Power wheelchair Mid wheel drive		
			<ul style="list-style-type: none"> • Q-Logic 3 expandable electronics • Smooth ride suspension (SRS) • 2 pole motors • Seat to floor height min 16.5" • Overall width 24.4" • Overall length (excluding footplates) 32.23" • 12-24"x12-24" <p>Accessory Code: ENZ LIST CODE: ENZA4 ACC SIC CODE: EM104A</p> <p>Click here for script form</p> <p>PLEASE NOTE: QUOTE & ACCESSORY CODE IS REQUIRED WITH REQUEST.</p>		
SUPPLIER/BRAND			MAX USER WEIGHT		
Allied Medical/Edge			136kg		
SUPPLIER PRODUCT ID	ENZ LIST CODE	DESCRIPTION	SIZE	ACC SIC CODE	
PKBASEEDGE3T	ENZA1017	TILT READY BASE ONLY	12-24x12-24	EM104	
PKBASEEDGE3R	ENZA4018	REAC READY BASE ONLY	12-24x12-24	EM104	

Power Wheelchair				Complex	
			SPECIFICATIONS TDXSP2 Mid Wheel Drive		
			<ul style="list-style-type: none"> • Linux expanadable electronics • Drive wheel 14" • 4 Pole Motor • Base length: 35.5" • Base width 24",25.5" <p>Accessory Codes : ENZ LIST CODE: ENZA5 ACC SIC CODE: EM120A</p> <p>PLEASE NOTE: QUOTE & ACCESSORY CODE IS REQUIRED WITH REQUEST.</p>		
SUPPLIER/BRAND			MAX USER WEIGHT		
Invacare/TDXSP2			136kg		
SUPPLIER PRODUCT ID	ENZ LIST CODE	SIZE (width x depth)	ACC SIC CODE		
TDXSP2-BASE-ANZ	ENZA267	12-22x12-24"	EM120		

ACC Complex List Equipment

Wheelchair & Seating

Power Wheelchair		Complex	
		SPECIFICATIONS TAIQMWD Mid Wheel Drive <ul style="list-style-type: none"> • RNET expandable electronics • Drive wheel size 35cm/14" • Castor wheel size 20cm/8" • Floor to seat height min 38-43cm/15-17" • Floor to seat height max 68-73cm/27-29" • Overall width 60-63cm/23.5-25" • Overall length without footrests 91cm/36" 	
		Accessory Codes: ENZ LIST CODE: ENZA6 ACC SIC CODE: EM122A PLEASE NOTE: QUOTE & ACCESSORY CODE IS REQUIRED WITH REQUEST.	
SUPPLIER/BRAND		MAX USER WEIGHT	
Morton & Perry/TAIQ		140kg	
SUPPLIER PRODUCT ID	ENZ LIST CODE	SEAT SIZE (width x depth)	ACC SIC CODE
XTAIQMWD02	ENZA269	37-55x35-55cm	EM122